

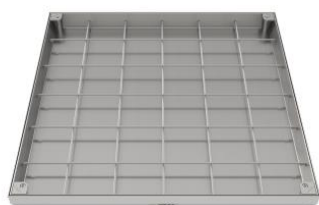

ferro fundido

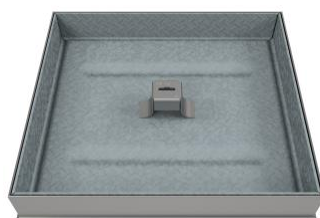

Inox / alumínio



galvanizado



betão polímero



## TABELA DE PREÇOS

# 2026

Em vigor a 18/04/2026



## APRESENTAÇÃO

CAPA Drain é uma divisão do grupo CAPA especializada na concepção, fabrico e comercialização de sistemas de drenagem e acesso às redes de infraestruturas subterrâneas. É uma empresa líder, com experiência assimilada em mais de 30 anos de atividade, no desenvolvimento de soluções de acesso a câmaras de visita, tanto para infraestruturas húmidas (abastecimento de águas, águas pluviais, águas residuais, domésticas ou industriais), como para infraestruturas secas (electricidade, telecomunicações, caixas de manobra, entre outros).

A alta capacidade técnica permite-nos desenvolver produtos que se caracterizam pela habilidade, resistência e durabilidade. A certificação pela ISO 9001, implementada em 2003, é uma forte garantia de sermos uma empresa forte e competitiva, assegurando uma resposta global às suas necessidades.

O nosso objetivo é o de criar valor para os nossos clientes, desenvolvendo para o efeito sistemas inovadores e de elevada qualidade que garantam durabilidade e funcionalidade no acesso às redes de infraestutura.

## redondas articuladas

round hinged manhole covers

Ø400

ref	mod.	Ø aro	altura	Ø ab. útil	un	preço
922023	EASYFLEX 600	830	100	600	12	192,50 €
922123	FLEXUS 600	800	100	575	12	170,50 €

\* Tráfego intenso



## redondas articuladas

round hinged manhole covers

Ø400

ref	mod.	Ø aro	altura	Ø ab. útil	un	preço
922130	KARGO 600	750	100	600	11	154,00 €
922129	PRYMA 600	730	100	580	12	137,50 €
922021	RL600	735	75	550	15	115,50 €

\* Tráfego moderado



## redondas rebaixadas

round recessed manhole covers

Ø400

ref	mod.	Ø aro	altura	Ø ab. útil	un	preço
922060	600	755	80 (50)	600	11	187,00 €



Vedação Hidráulica

## redondas

round manhole covers

Ø400

ref	mod.	Ø aro	altura	Ø ab. útil	un	preço
922313	500	620	45	500	26	126,50 €

## redondas

round manhole covers

Ø250

ref	mod.	Ø aro	altura	Ø ab. útil	un	preço
922213	500	620	45	500	25	99,00 €



Vedação Hidráulica

## redondas

round manhole covers

Ø125

ref	mod.	Ø aro	altura	Ø ab. útil	un	preço
922012	500R	575	40	475	50	66,00 €
922013	500	620	45	500	46	73,70 €
922015	600R	660	40	550	50	82,50 €
922014	600	720	50	600	25	110,00 €

# ferro fundido



Vedação  
Hidráulica



Ø400

## rasas Traffic

Traffic square manhole covers

ref	mod.	ab. útil	altura	un	preço
920313	500	400x400	75	52	<b>132,00 €</b>
920314	600	500x500	75	16	<b>154,00 €</b>
920315	700	600x600	100	14	<b>220,00 €</b>
920316	800	700x700	100	10	<b>308,00 €</b>
920317	900	800x800	100	6	<b>473,00 €</b>
920318	1000	900x900	100	8	<b>616,00 €</b>
920319	1100	1000x1000	90	10	<b>770,00 €</b>



Vedação  
Hidráulica

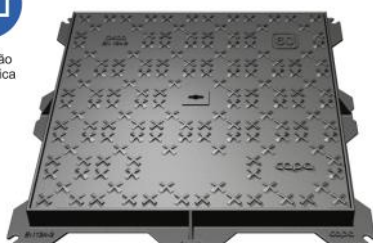

Ø400

## rasas SP

SP square manhole covers

ref	mod.	ab. útil	altura	un	preço
920413	500	400x400	50	52	<b>99,00 €</b>
920414	600	500x500	50	40	<b>126,50 €</b>
920415	700	600x600	70	24	<b>198,00 €</b>



Vedação  
Hidráulica



Ø250

## rasas Park

Park square manhole covers

ref	mod.	ab. útil	altura	un	preço
920212	400	300x300	40	60	<b>57,20 €</b>
920213	500	400x400	45	52	<b>90,20 €</b>
920214	600	500x500	50	36	<b>108,90 €</b>
920215	700	600x600	50	20	<b>165,00 €</b>



Vedação  
Hidráulica

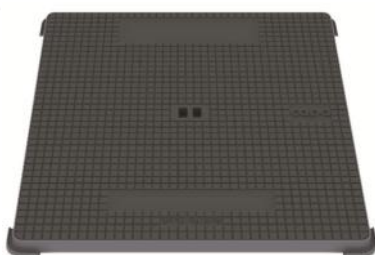

Ø125

## rasas Douro

Douro square manhole covers

ref	mod.	ab. útil	altura	un	preço
920111	300	217x217	30	300	<b>17,60 €</b>
920112	400	300x300	30	132	<b>26,40 €</b>
920113	500	400x400	35	60	<b>58,30 €</b>
920114	600	500x500	35	40	<b>73,70 €</b>
920115	700	600x600	45	25	<b>139,70 €</b>
920116	800	700x700	45	25	<b>170,50 €</b>
920117	900	800x800	45	25	<b>258,50 €</b>

# ferro fundido

## rebaixadas *Portus*

*Portus recessed covers*

b125

ref	mod.	ab. útil	altura	un	preço
921012	400	300x300	50 (30)	78	44,00 €
921013	500	400x400	50 (30)	72	63,80 €
921014	600	500x500	50 (30)	40	94,60 €
921015	700	600x600	50 (30)	24	132,00 €
921016	800	700x700	50 (30)	24	220,00 €

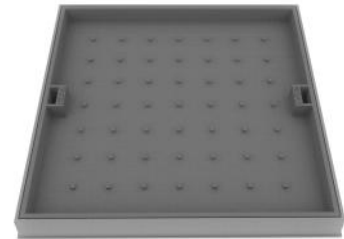

Vedação  
Hidráulica

## basalto

*recessed covers*

d400

ref	mod.	ab. útil	altura	un	preço
921051	500	400x400	85/115 (60)	22	132,00 €
921052	600	500x500	85/130 (60)	22	187,00 €

## basalto

*recessed covers*

c250

ref	mod.	ab. útil	altura	un	preço
921040	400	300x300	75 (50)	48	77,00 €
921041	500	400x400	75 (50)	52	115,50 €
921042	600	500x500	75 (50)	26	148,50 €
921043	700	600x600	75 (50)	20	192,50 €

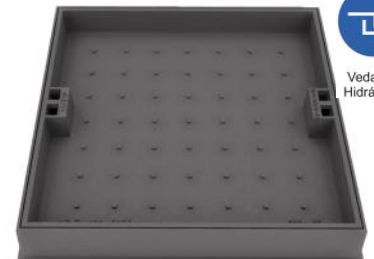

Vedação  
Hidráulica

## basalto

*recessed covers*

b125

ref	mod.	ab. útil	altura	un	preço
921031	500	400x400	75 (50)	52	88,00 €
921032	600	500x500	75 (50)	28	115,50 €

## ferro fundido



Ø400

### rasas articuladas modelo NR

NR type manhole covers

ref	comp. x larg.	ab. útil	altura	un	preço
920512	1340x970	1200x750 (NR2)	120	7	<b>792,00 €</b>
920513	1640x932	1500x750 (NR3)	120	7	<b>869,00 €</b>



Ø400

### rasas modelo NR

NR type manhole covers

ref	comp. x larg.	ab. útil	altura	un	preço
920501	745x940	600x750 (NR1)	80/120	7	<b>390,50 €</b>
920502	1320x900	1200x750 (NR2)	80/120	7	<b>759,00 €</b>



Ø125

### rasas modelo NR

NR type manhole covers

ref	comp. x larg.	ab. útil	altura	un	preço
920401	680x830	600x750 (NR1)	40/80	20	<b>198,00 €</b>
920402	1280x830	1200x750 (NR2)	40/80	12	<b>363,00 €</b>
920403	1580x830	1500x750 (NR3)	40/80	10	<b>451,00 €</b>

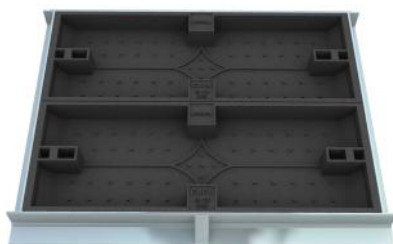

Ø125

### rebaixadas modelo NR

NR type recessed filled covers

ref	comp. x larg.	ab. útil	altura	un	preço
921501	720x870	600x750 (NR1)	60/110 (55)	10	<b>247,50 €</b>
921502	1320x870	1200x750 (NR2)	60/110 (55)	10	<b>456,50 €</b>
921503	1620x870	1500x750 (NR3)	60/110 (55)	10	<b>506,00 €</b>

rasas modulares *Combi*

*Combi type manhole covers*

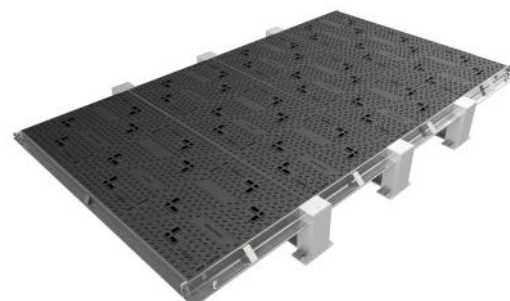

ref	mod.	dimens.	ab. útil	altura	preço
9206.006	L0.T6	880x1960	716x1800	80 (120)	SC
9206.008	L0.T8	880x2560	716x2400	80 (120)	SC
9206.010	L0.T10	880x3160	716x3000	80 (120)	SC
9206.012	L0.T12	880x3760	716x3600	80 (120)	SC
9206.114	L1.T8.V20	1670x1425	1500x1200	80 (288)	SC
9206.124	L2.T12.V20	2470x1425	2300x1200	80 (288)	SC
9206.134	L3.T16.V20	3270x1425	3100x1200	80 (288)	SC
9206.116	L1.T12.V24	1670x2025	1500x1800	80 (328)	SC
9206.126	L2.T18.V24	2470x2025	2300x1800	80 (328)	SC
9206.136	L3.T24.V24	3270x2025	3100x1800	80 (328)	SC
9206.118	L1.T16.V30	1670x2625	1500x2400	80 (388)	SC
9206.128	L2.T24.V30	2470x2625	2300x2400	80 (388)	SC
9206.138	L3.T32.V30	3270x2625	3100x2400	80 (388)	SC

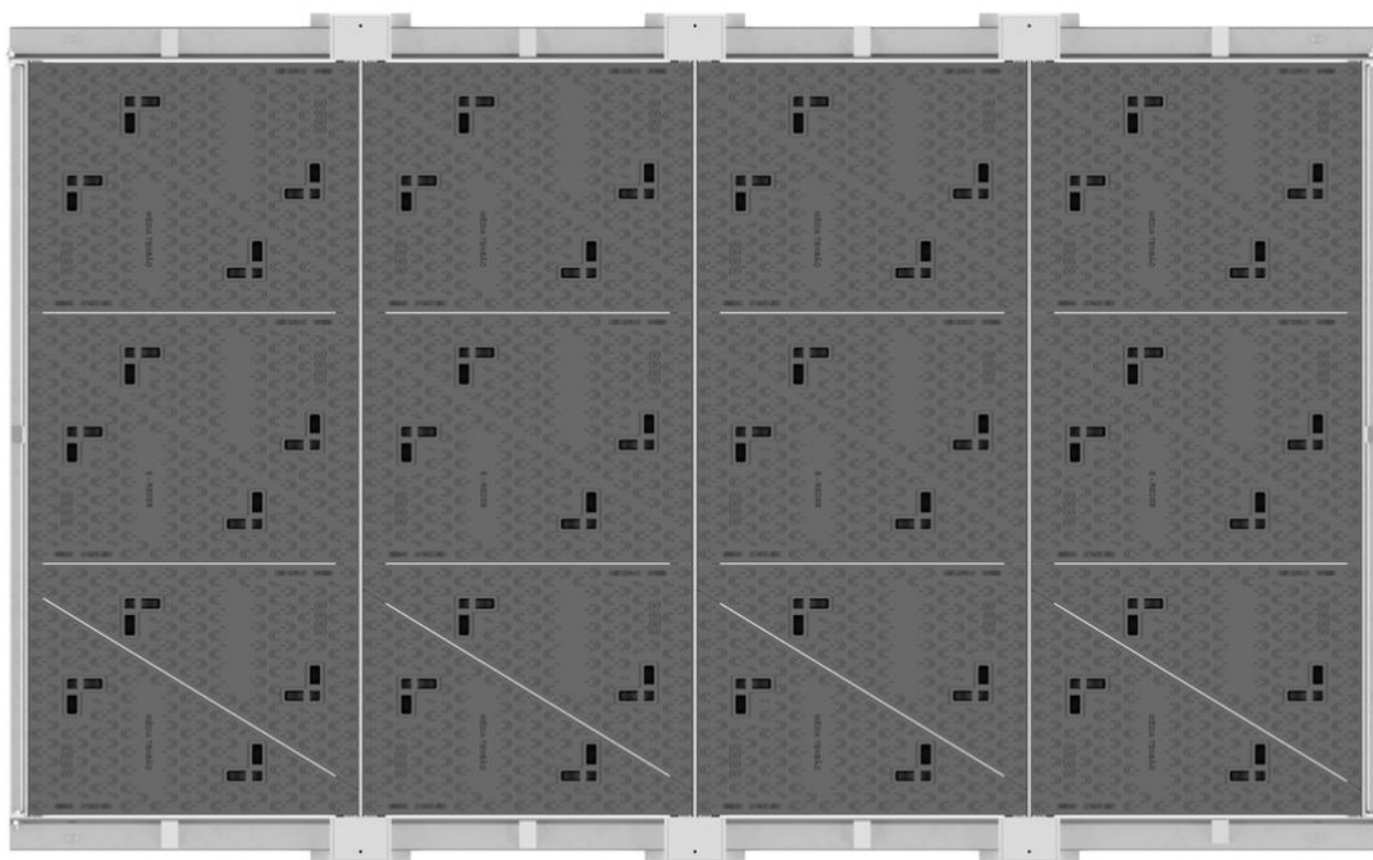

# ferro fundido

b125

## rebaixadas modulares *Combi*

*Combi type recessed filled covers*

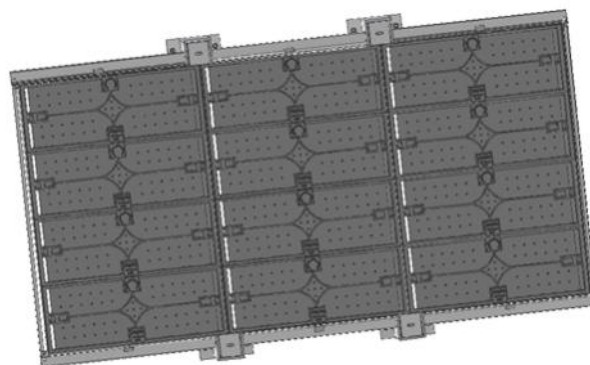
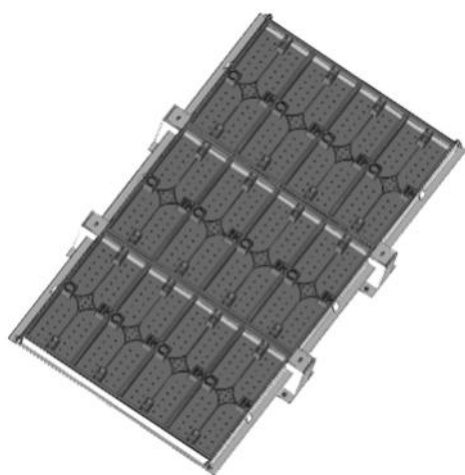
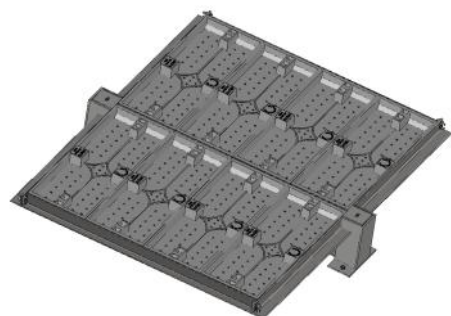

ref	mod.	dimens.	ab. útil	altura	preço
9216.006	R0.T6	880x1920	750x1800	60 (84)	SC
9216.008	R0.T8	880x2520	750x2400	60 (84)	SC
9216.010	R0.T10	880x3120	750x3000	60 (84)	SC
9216.012	R0.T12	880x3720	750x3600	60 (84)	SC
9216.114	R1.T8.V14	1630x1425	1560x1200	60 (208)	SC
9216.124	R2.T12.V14	2440x1425	2370x1200	60 (208)	SC
9216.134	R3.T16.V14	3250x1425	3180x1200	60 (208)	SC
9216.116	R1.T12.V18	1630x2025	1560x1800	60 (248)	SC
9216.126	R2.T18.V18	2440x2025	2370x1800	60 (248)	SC
9216.136	R3.T24.V18	3250x2025	3180x1800	60 (248)	SC
9216.118	R1.T16.V24	1630x2625	1560x2400	60 (308)	SC
9216.128	R2.T24.V24	2440x2625	2370x2400	60 (308)	SC
9216.138	R3.T32.V24	3250x2625	3180x2400	60 (308)	SC

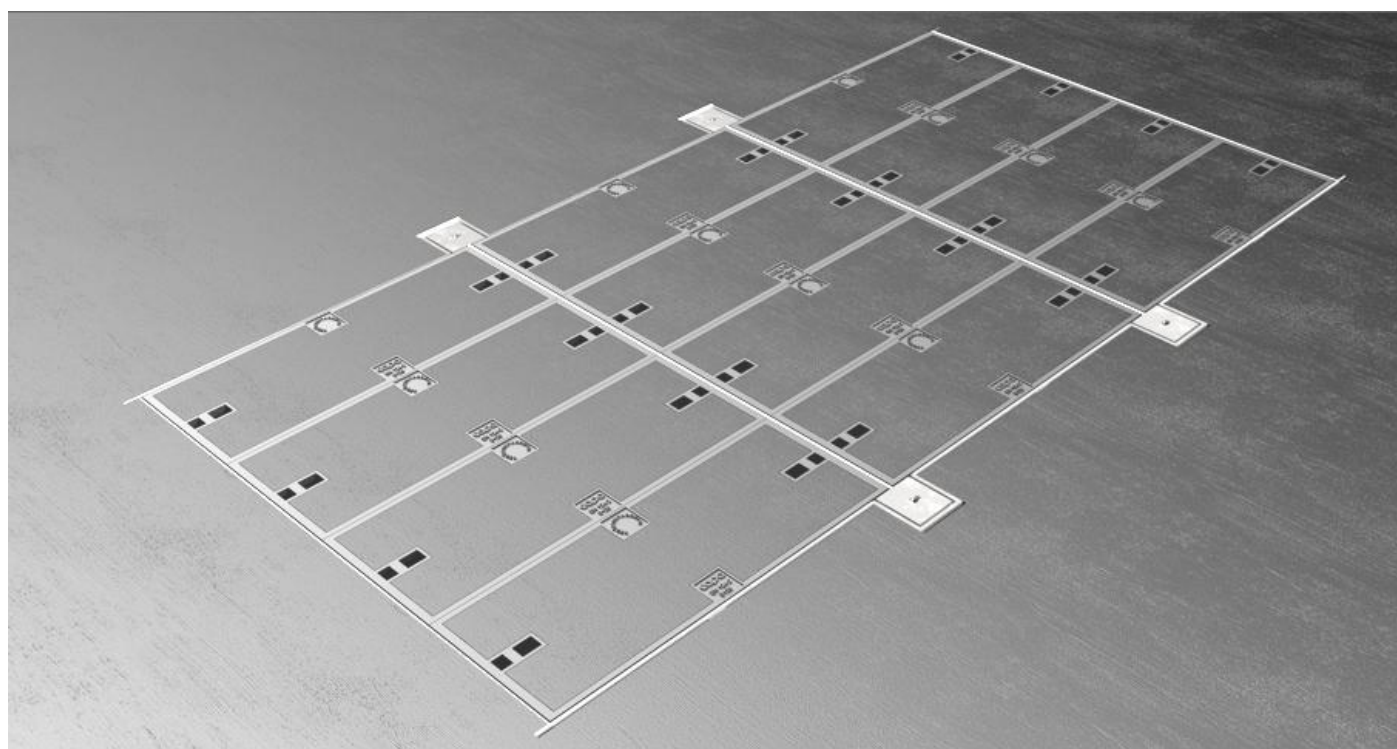

**canais FFD VLine**

casting channel VLine

d400

ref	mod.	comp. x larg.	altura	un	preço
924500	100	1000x140	130	64	66,00 €
924501	150	1000x200	170	36	115,50 €
924502	200	750x260	200	25	121,00 €



**sumidouro Easydrain**

Easydrain round grating

d400

ref	mod.	Ø aro	Ø ab. útil	altura	un	preço
922050	600	850	600	100	12	176,00 €



**sumidouro antirroubo**

sink gratings

d400

ref	comp.	larg.	altura	un	preço
924112	555	320	40 / 65	45	71,50 €
924114	706	380	50 / 75	24	99,00 €



**sumidouro antirroubo**

sink gratings

C250

ref	comp.	larg.	altura	un	preço
924102	555	320	40	60	57,20 €
924103	630	280	40	63	51,70 €
924104	706	380	40	40	80,30 €

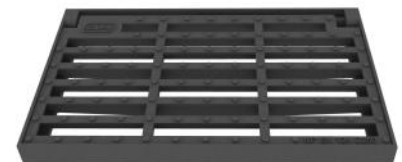

**sumidouro antirroubo Pluvea**

Pluvea sink square grating

d400

ref	dim.	ab. útil	altura	un	preço
924540	400x400	300x300	75	32	88,00 €
924550	500x500	400x400	75	32	121,00 €
924560	600x600	500x500	75	16	165,00 €
924570	700x700	600x600	75	10	231,00 €
924580	800x800	700x700	75	8	330,00 €



**sumidouro antirroubo Pluvea**

Pluvea sink square grating

C250

ref	dim.	ab. útil	altura	un	preço
924440	400x400	300x300	30/55	60	55,00 €
924450	500x500	400x400	40/85	60	88,00 €
924460	600x600	500x500	40/85	22	110,00 €



# ferro fundido



E600

## grelha antirroubo Linea

Linea Grating

ref	comp.	larg.	altura	un	preço
924214	750	400	78/65	54	<b>235,40 €</b>

Nota: Grelha inclui aro e fixação da grelha por 4 parafusos. Abertura útil: 350 mm.



d400

## grelha antirroubo Linea

Linea Grating

ref	comp.	larg.	altura	un	preço
924201	650	350	30/45	54	<b>132,00 €</b>



d400

## grelhas passarela FFD

gratings ductil iron

ref	comp.	larg.	altura	un	preço
924001	500	123	23	240	<b>15,40 €</b>
924002	500	188	23	250	<b>27,50 €</b>
924003	500	240	23	176	<b>39,60 €</b>
924004	500	300	23	132	<b>53,90 €</b>



b125

## grelhas passarela FFD

gratings ductil iron

ref	comp.	larg.	altura	un	preço
924051	500	150	25	120	<b>17,60 €</b>
924052	500	200	25	120	<b>25,30 €</b>



## aros passarela FFD

frames for gratings

ref	comp.	larg.	altura	para grelha ref.	un	preço
503A.13.FF	1000	130	25	924001	50	<b>25,30 €</b>
503A.20.FF	1000	200	25	924002	50	<b>27,50 €</b>
503A.25.FF	1000	250	25	924003	50	<b>28,60 €</b>
503A.30.FF	1000	310	25	924004	50	<b>31,90 €</b>
503A.13M.FF	510	130	25	924001	50	<b>22,00 €</b>
503A.20M.FF	510	200	25	924002	50	<b>24,20 €</b>
503A.25M.FF	510	250	25	924003	50	<b>25,30 €</b>
503A.30M.FF	510	310	25	924004	50	<b>28,60 €</b>
503A.16.FF	1000	160	25	924051	50	<b>25,30 €</b>
503A.20.FF	1000	210	25	924052	50	<b>27,50 €</b>
503A.37.FF	1300	365	35	924201	50	<b>51,70 €</b>
MP.D912T.M8.50.P	Parafuso para grelhas em FF					<b>0,33 €</b>

Nota: Parafusos não incluídos no preço do aro

## ralos de pavimento

surface drain

ref	Dim.	Ø saída	altura	sup. abs.	classe	preço
927001	185x185	125	146	110 cm <sup>2</sup>	M125	66,00 €
927002	185x185	110	170	110 cm <sup>2</sup>	M125	66,00 €
927011	200x200	75	60	37 cm <sup>2</sup>	L15	33,00 €



## cabeças móveis

surface box

ref	mod.	Ø ab. útil	Ø tampa	altura	un	preço
com corrente						
926013	redonda	102	90	160	294	18,15 €
926014	quadrada	102	90	160	294	18,15 €
sem corrente						
926003	redonda	102	90	160	294	15,84 €
926004	quadrada	102	90	160	294	15,84 €
926005	triangular	102	90	160	294	15,84 €
926006	hezagonal	102	90	160	294	15,84 €



## caixa cilíndrica R200

cylindrical box R200

ref	mod.	Ø ab. útil	Ø tampa	altura	un	preço
926010	R200	200	193	50	294	55,00 €



## degraus

steps

ref	descrição	caixa	un	preço
922036	degrau reto em PP	30	810	4,40 €
922035	degrau curvo em PP	25	1125	5,28 €



## acessórios tampas de visita

accessories manhole covers

ref	descrição	preço
508700	Chave de manobra para modelos NR	16,50 €
508704	Chave de Manobra em "T" c/ 72cm	16,50 €
508701	Chave de Manobra em "T" c/ 25cm	11,00 €
928005	Placas de inscrição para tampas rebaixadas	13,75 €
928001	Apoio elástico para modelos articulados	19,25 €
928003	Fecho de segurança adicional para modelos articulados	22,00 €



## ralo sumidouro saída vertical EVO

floor drain with vertical outlet EVO

ref		L	Ht	H	h	Dc	DN	caudal	preço	
<i>aisi304</i>	<i>aisi316</i>	(mm)	(mm)	(mm)	(mm)	(mm)	(mm)	(l/s)	<i>aisi304</i>	<i>aisi316</i>
57S.41.15V	57S.61.15V	150	205	205	50	110	110	1,4	209,00 €	247,50 €
57S.41.20V	57S.61.20V	200	275	215	50	170	110	2,0	302,50 €	352,00 €
57S.41.25V	57S.61.25V	250	275	215	50	170	110	2,0	335,50 €	385,00 €

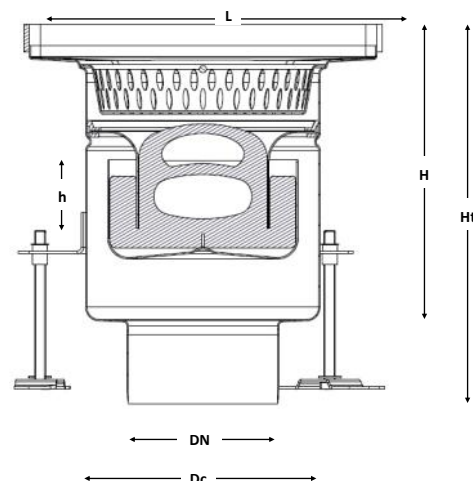

## ralo sumidouro saída horizontal EVO

floor drain with horizontal outlet EVO

ref		L	Ht	H	h	Dc	DN	caudal	preço	
<i>aisi304</i>	<i>aisi316</i>	(mm)	(mm)	(mm)	(mm)	(mm)	(mm)	(l/s)	<i>aisi304</i>	<i>aisi316</i>
57S.41.15V + 57A.41.SH	57S.61.15V + 57A.61.SH	150	205	205	50	110	75	1,4	209,00 € 82,50 €	247,50 € 93,50 €
57S.41.20H	57S.61.20H	200	275	215	50	170	110	2,0	302,50 €	352,00 €
57S.41.25H	57S.61.25H	250	275	215	50	170	110	2,0	335,50 €	385,00 €

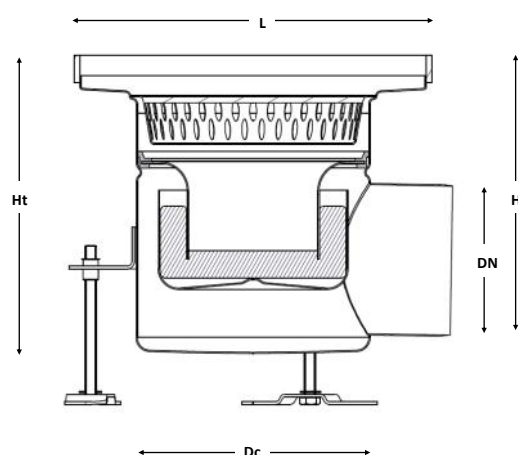

**grelhas EVO**

EVO gratings

ref		C	L	H	classe	tipo	preço	
<i>aisi304</i>	<i>aisi316</i>						<i>aisi304</i>	<i>aisi316</i>
5G.B4.150Q	5G.B6.150Q	148	148	25	C250	barra	<b>60,50 €</b>	<b>66,00 €</b>
5G.C4.150Q	5G.C6.150Q	148	148	25	C250	cega	<b>66,00 €</b>	<b>71,50 €</b>
5G.PL4.150Q	5G.PL6.150Q	148	148	25	A15	perf. L	<b>33,00 €</b>	<b>38,50 €</b>
5G.B4.200Q	5G.B6.200Q	198	198	25	C250	barra	<b>77,00 €</b>	<b>88,00 €</b>
5G.C4.200Q	5G.C6.200Q	198	198	25	C250	cega	<b>82,50 €</b>	<b>93,50 €</b>
5G.PL4.200Q	5G.PL6.200Q	198	198	25	A15	perf. L	<b>49,50 €</b>	<b>60,50 €</b>
5G.B4.250Q	5G.B6.250Q	248	248	25	C250	barra	<b>99,00 €</b>	<b>110,00 €</b>
5G.C4.250Q	5G.C6.250Q	248	248	25	C250	cega	<b>104,50 €</b>	<b>121,00 €</b>
5G.PL4.250Q	5G.PL6.250Q	248	248	25	A15	perf. L	<b>66,00 €</b>	<b>77,00 €</b>



Perfurada  
Ref. 5G.PL4.200



Cega  
Ref. 5G.C4.200Q



Barra  
Ref. 5G.B4.200Q

**sifão**

trap DN110

ref		L	H	h água	preço	
<i>aisi304</i>	<i>aisi316</i>				<i>aisi304</i>	<i>aisi316</i>
57A.41.S	57A.61.S	108	99	50	<b>104,50 €</b>	<b>115,50 €</b>
57A.41.S1	57A.61.S	108	99	50	<b>126,50 €</b>	<b>137,50 €</b>



**cesto DN110**

basket DN110

ref		L	H	vol	preço	
<i>aisi304</i>	<i>aisi316</i>			L	<i>aisi304</i>	<i>aisi316</i>
57A.41.C1	57A.61.C1	108	99	0,22	<b>27,50 €</b>	<b>33,00 €</b>
57A.41.C2	57A.61.C2	108	99	0,66	<b>33,00 €</b>	<b>38,50 €</b>





## canal Easychannel 180

channel with slope Easychannel 180

ref		C	L	H1	H2	preço	
<i>aisi304</i>	<i>aisi316</i>					<i>aisi304</i>	<i>aisi316</i>
56.4.15.08	56.6.15.08	830	180	60	70	<b>418,00 €</b>	<b>495,00 €</b>
56.4.15.10	56.6.15.10	1030	180	60	70	<b>440,00 €</b>	<b>522,50 €</b>
56.4.15.12	56.6.15.12	1230	180	60	70	<b>462,00 €</b>	<b>550,00 €</b>
56.4.15.15	56.6.15.15	1530	180	60	70	<b>495,00 €</b>	<b>583,00 €</b>

A box Easychannel 180 inclui sifão DN110 e cesto.  
A grelha não está incluída.

## canal Easychannel 230

channel with slope Easychannel 230



ref		C	L	H1	H2	preço	
<i>aisi304</i>	<i>aisi316</i>					<i>aisi304</i>	<i>aisi316</i>
56.4.20.08	56.6.20.08	830	230	60	70	<b>440,00 €</b>	<b>511,50 €</b>
56.4.20.10	56.6.20.10	1030	230	60	70	<b>462,00 €</b>	<b>539,00 €</b>
56.4.20.12	56.6.20.12	1230	230	60	70	<b>484,00 €</b>	<b>566,50 €</b>
56.4.20.15	56.6.20.15	1530	230	60	70	<b>517,00 €</b>	<b>616,00 €</b>

A box Easychannel 230 inclui sifão DN110 e cesto.  
A grelha não está incluída.

## box Easychannel 530

box with slope Easychannel 530



ref		C	L	H1	H2	preço	
<i>aisi304</i>	<i>aisi316</i>					<i>aisi304</i>	<i>aisi316</i>
56.4.50.10	56.6.50.10	1030	530	65	80	<b>638,00 €</b>	<b>792,00 €</b>
56.4.50.20	56.6.50.20	2030	530	65	80	<b>891,00 €</b>	<b>1 155,00 €</b>

A box Easychannel 530 inclui sifão DN170 e cesto.  
A grelha não está incluída.

## box Easychannel 1030

box with slope Easychannel 1030

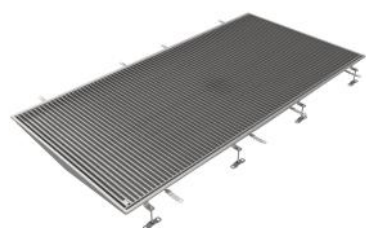

ref		C	L	H1	H2	preço	
<i>aisi304</i>	<i>aisi316</i>					<i>aisi304</i>	<i>aisi316</i>
56.4.100.20	56.6.100.20	2030	1030	80	95	<b>1 243,00 €</b>	<b>1 705,00 €</b>

A box Easychannel 1030 inclui sifão DN170 e cesto.  
A grelha não está incluída.

## corpo sumidouro com saída

body with outlet



ref		L	H	DN	saída	preço	
<i>aisi304</i>	<i>aisi316</i>					<i>aisi304</i>	<i>aisi316</i>
57A.41.SH	57A.61.SH	139	155	75	Hor.	<b>82,50 €</b>	<b>93,50 €</b>
57A.41.SH1	57A.61.SH1	199	155	110	Hor.	<b>126,50 €</b>	<b>143,00 €</b>
57A.41.SV1	57A.61.SV1	199	155	110	Vert.	<b>121,00 €</b>	<b>137,50 €</b>

## grelhas *Easychannel*

*Easychannel gratings*

ref		C	L	H	classe	tipo	preço	
<i>aisi304</i>	<i>aisi316</i>						<i>aisi304</i>	<i>aisi316</i>
5G.QA4.150	5G.QA6.150	999	148	25	B125	Entr. AD	<b>165,00 €</b>	<b>192,50 €</b>
5G.QA4.150M	5G.QA6.150M	499	148	25	B125	Entr. AD	<b>99,00 €</b>	<b>115,50 €</b>
5G.B4.150	5G.B6.150	999	148	25	C250	barra	<b>192,50 €</b>	<b>231,00 €</b>
5G.B4.150M	5G.B6.150M	499	148	25	C250	barra	<b>115,50 €</b>	<b>143,00 €</b>
5G.C4.150	5G.C6.150	999	148	25	C250	cega	<b>255,50 €</b>	<b>275,00 €</b>
5G.C4.150M	5G.C6.150M	499	148	25	C250	cega	<b>132,00 €</b>	<b>159,50 €</b>
5G.PL4.150	5G.PL6.150	999	148	25	A15	perf. L	<b>170,50 €</b>	<b>198,00 €</b>
5G.PL4.150M	5G.PL6.150M	499	148	25	A15	perf. L	<b>99,00 €</b>	<b>110,00 €</b>
5G.PR4.150	5G.PR6.150	999	148	25	B125	perf. R	<b>220,00 €</b>	<b>257,50 €</b>
5G.PR4.150M	5G.PR6.150M	499	148	25	B125	perf. R	<b>121,00 €</b>	<b>143,00 €</b>
5G.QA4.200	5G.QA6.200	999	198	25	B125	Entr. AD	<b>176,00 €</b>	<b>214,50 €</b>
5G.QA4.200M	5G.QA6.200M	499	198	25	B125	Entr. AD	<b>110,00 €</b>	<b>137,50 €</b>
5G.B4.200	5G.B6.200	999	198	25	C250	barra	<b>225,50 €</b>	<b>275,00 €</b>
5G.B4.200M	5G.B6.200M	499	198	25	C250	barra	<b>137,50 €</b>	<b>154,00 €</b>
5G.C4.200	5G.C6.200	999	198	25	C250	cega	<b>264,00 €</b>	<b>330,00 €</b>
5G.C4.200M	5G.C6.200M	499	198	25	C250	cega	<b>154,00 €</b>	<b>192,50 €</b>
5G.PL4.200	5G.PL6.200	999	198	25	A15	perf. L	<b>192,50 €</b>	<b>231,00 €</b>
5G.PL4.200M	5G.PL6.200M	499	198	25	A15	perf. L	<b>110,00 €</b>	<b>132,00 €</b>
5G.PR4.200	5G.PR6.200	999	198	25	B125	perf. R	<b>253,00 €</b>	<b>297,00 €</b>
5G.PR4.200M	5G.PR6.200M	499	198	25	B125	perf. R	<b>137,50 €</b>	<b>165,00 €</b>
5G.QA4.500	5G.QA6.500	999	498	25	A15	Entr. AD	<b>473,00 €</b>	<b>572,00 €</b>
5G.B4.500	5G.B6.500	999	498	25	A15	barra	<b>495,00 €</b>	<b>616,00 €</b>

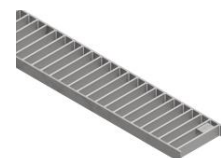

## sifão

*trap*

ref		L	H	h água	preço	
<i>aisi304</i>	<i>aisi316</i>				<i>aisi304</i>	<i>aisi316</i>
57A.41.S	57A.61.S	108	99	50	<b>104,50 €</b>	<b>115,50 €</b>
57A.41.S1	57A.61.S	168	99	50	<b>126,50 €</b>	<b>137,50 €</b>



## cesto

*basket*

ref		L	H	vol	preço	
<i>aisi304</i>	<i>aisi316</i>			<i>L</i>	<i>aisi304</i>	<i>aisi316</i>
57A.41.C0	57A.61.C0	108	99	-	<b>16,50 €</b>	<b>18,70 €</b>
57A.41.C3	57A.61.C3	168	99	0,66	<b>33,00 €</b>	<b>38,50 €</b>



## canal modular sem pendente *Modultek 125*

*modular channel without slope Modultek 125*



ref		C	L	H1	H2	preço	
<i>aisi304</i>	<i>aisi316</i>					<i>aisi304</i>	<i>aisi316</i>
57.41.0.C1	57.61.0.C1	500	155	50	50	176,00 €	209,00 €
57.41.0.C2	57.61.0.C2	500	155	65	65	181,50 €	220,00 €
57.41.0.C3	57.61.0.C3	500	155	80	80	192,50 €	231,00 €
57.41.0.C4	57.61.0.C4	500	155	95	95	203,50 €	242,00 €
57.41.0.C5	57.61.0.C5	500	155	110	110	214,50 €	253,00 €
57.41.0.C6	57.61.0.C6	500	155	125	125	225,50 €	264,00 €
57.41.1.C1	57.61.1.C1	1000	155	50	50	214,50 €	258,50 €
57.41.1.C2	57.61.1.C2	1000	155	65	65	231,00 €	275,00 €
57.41.1.C3	57.61.1.C3	1000	155	80	80	242,00 €	291,50 €
57.41.1.C4	57.61.1.C4	1000	155	95	95	253,00 €	308,00 €
57.41.1.C5	57.61.1.C5	1000	155	110	110	269,50 €	324,50 €
57.41.1.C6	57.61.1.C6	1000	155	125	125	286,00 €	341,00 €
57.41.2.C1	57.61.2.C1	2000	155	50	50	308,00 €	385,00 €
57.41.2.C2	57.61.2.C2	2000	155	65	65	330,00 €	412,50 €
57.41.2.C3	57.61.2.C3	2000	155	80	80	352,00 €	440,00 €
57.41.2.C4	57.61.2.C4	2000	155	95	95	374,00 €	467,50 €
57.41.2.C5	57.61.2.C5	2000	155	110	110	396,00 €	495,00 €
57.41.2.C6	57.61.2.C6	2000	155	125	125	418,00 €	522,50 €
57.41.3.C1	57.61.3.C1	3000	155	50	50	379,50 €	489,50 €
57.41.3.C2	57.61.3.C2	3000	155	65	65	407,00 €	528,00 €
57.41.3.C3	57.61.3.C3	3000	155	80	80	434,50 €	566,50 €
57.41.3.C4	57.61.3.C4	3000	155	95	95	462,00 €	605,00 €
57.41.3.C5	57.61.3.C5	3000	155	110	110	489,50 €	643,50 €
57.41.3.C6	57.61.3.C6	3000	155	125	125	517,00 €	682,00 €

## canal modular "L" *Modultek 125*

*modular channel type "L" Modultek 125*



ref		C	L	H1	H2	preço	
<i>aisi304</i>	<i>aisi316</i>					<i>aisi304</i>	<i>aisi316</i>
57.41.0.L1	57.61.0.L1	515	640	50	50	253,00 €	302,50 €
57.41.0.L3	57.61.0.L3	515	640	80	80	275,00 €	335,50 €



## canal modular "T" *Modultek 125*

*modular channel type "T" Modultek 125*

ref		C	L	H1	H2	preço	
<i>aisi304</i>	<i>aisi316</i>					<i>aisi304</i>	<i>aisi316</i>
57.41.0.T1	57.61.0.T1	500	640	50	50	264,00 €	324,50 €
57.41.0.T3	57.61.0.T3	500	640	80	80	297,00 €	368,50 €

### canal modular com pendente Modultek 125

modular channel with slope Modultek 125

ref		C	L	H1	H2	preço	
aisi304	aisi316					aisi304	aisi316
57.41.0.P1	57.61.0.P1	500	155	50	65	192,50 €	231,00 €
57.41.0.P2	57.61.0.P2	500	155	65	80	203,50 €	242,00 €
57.41.1.P1	57.61.1.P1	1000	155	50	65	231,00 €	286,00 €
57.41.1.P2	57.61.1.P2	1000	155	65	80	242,00 €	302,50 €
57.41.2.P1	57.61.2.P1	2000	155	50	65	330,00 €	418,00 €
57.41.2.P2	57.61.2.P2	2000	155	65	80	352,00 €	445,50 €
57.41.2.P3	57.61.2.P3	2000	155	80	95	374,00 €	473,00 €
57.41.2.P4	57.61.2.P4	2000	155	95	110	396,00 €	500,50 €
57.41.2.P5	57.61.2.P5	2000	155	110	125	418,00 €	528,00 €
57.41.3.P1	57.61.3.P1	3000	155	50	65	423,50 €	539,00 €
57.41.3.P2	57.61.3.P2	3000	155	65	80	451,00 €	572,00 €
57.41.3.P3	57.61.3.P3	3000	155	80	95	478,50 €	605,00 €
57.41.3.P4	57.61.3.P4	3000	155	95	110	506,00 €	638,00 €
57.41.3.P5	57.61.3.P5	3000	155	110	125	533,50 €	682,00 €



### canal modular com saída central Modultek 125

modular channel with central outlet Modultek 125

ref		C	L	H1	DN	preço	
aisi304	aisi316					aisi304	aisi316
57.41.0.SC1	57.61.0.SC1	500	155	50	110	231,00 €	258,50 €
57.41.0.SC2	57.61.0.SC2	500	155	65	110	242,00 €	269,50 €
57.41.0.SC3	57.61.0.SC3	500	155	80	110	253,00 €	280,50 €
57.41.0.SC4	57.61.0.SC4	500	155	95	110	264,00 €	291,50 €
57.41.0.SC5	57.61.0.SC5	500	155	110	110	275,00 €	302,50 €
57.41.0.SC6	57.61.0.SC6	500	155	125	110	286,00 €	313,50 €



### canal modular com saída final Modultek 125

modular channel with final outlet Modultek 125

ref		C	L	H1	DN	preço	
aisi304	aisi316					aisi304	aisi316
57.41.1.SF1	57.61.1.SF1	1000	155	50	110	275,00 €	308,00 €
57.41.1.SF2	57.61.1.SF2	1000	155	65	110	286,00 €	324,50 €
57.41.1.SF3	57.61.1.SF3	1000	155	80	110	297,00 €	341,00 €
57.41.1.SF4	57.61.1.SF4	1000	155	95	110	308,00 €	363,00 €
57.41.1.SF5	57.61.1.SF5	1000	155	110	110	319,00 €	379,50 €
57.41.1.SF6	57.61.1.SF6	1000	155	125	110	330,00 €	396,00 €





## topo fechado *Modultek 125*

*closed end cap Modultek 125*

ref		C	L	H	DN	preço	
<i>aisi304</i>	<i>aisi316</i>					<i>aisi304</i>	<i>aisi316</i>
57A.41.TF1	57A.61.TF1	15	155	50	-	<b>36,30 €</b>	<b>39,60 €</b>
57A.41.TF2	57A.61.TF2	15	155	65	-	<b>37,40 €</b>	<b>40,70 €</b>
57A.41.TF3	57A.61.TF3	15	155	80	-	<b>38,50 €</b>	<b>41,80 €</b>
57A.41.TF4	57A.61.TF4	15	155	95	-	<b>39,60 €</b>	<b>42,90 €</b>
57A.41.TF5	57A.61.TF5	15	155	110	-	<b>40,70 €</b>	<b>44,00 €</b>
57A.41.TF6	57A.61.TF6	15	155	125	-	<b>41,80 €</b>	<b>45,10 €</b>



## topo com saída *Modultek 125*

*open end cap Modultek 125*

ref		C	L	H	DN	preço	
<i>aisi304</i>	<i>aisi316</i>					<i>aisi304</i>	<i>aisi316</i>
57A.41.TS2	57A.61.TS2	15	155	65	50	<b>45,10 €</b>	<b>49,50 €</b>
57A.41.TS3	57A.61.TS3	15	155	80	50	<b>46,20 €</b>	<b>50,60 €</b>
57A.41.TS4	57A.61.TS4	15	155	95	50	<b>47,30 €</b>	<b>51,70 €</b>
57A.41.TS5	57A.61.TS5	15	155	110	50	<b>48,40 €</b>	<b>52,80 €</b>
57A.41.TS6	57A.61.TS6	15	155	125	50	<b>49,50 €</b>	<b>53,90 €</b>



## Junta NBR *Modultek 125*

*NBR joint Modultek 125*

Ref	C	L	H	material	preço
57A.41.J1	15	155	50	NBR	<b>3,85 €</b>
57A.41.J2	15	155	65	NBR	<b>4,95 €</b>
57A.41.J3	15	155	80	NBR	<b>6,05 €</b>
57A.41.J4	15	155	95	NBR	<b>6,60 €</b>
57A.41.J5	15	155	110	NBR	<b>7,15 €</b>
57A.41.J6	15	155	125	NBR	<b>8,25 €</b>

**grelhas Modultek 125**

Modultek 125 gratings

ref		C	L	H	classe	tipo	preço	
<i>aisi304</i>	<i>aisi316</i>						<i>aisi304</i>	<i>aisi316</i>
5G.QA4.125	5G.QA6.125	999	123	25	B125	Entr. AD	<b>143,00 €</b>	<b>165,00 €</b>
5G.QA4.125M	5G.QA6.125M	499	123	25	B125	Entr. AD	<b>88,00 €</b>	<b>104,50 €</b>
5G.B4.125	5G.B6.125	999	123	25	C250	barra	<b>170,50 €</b>	<b>203,50 €</b>
5G.B4.125M	5G.B6.125M	499	123	25	C250	barra	<b>104,50 €</b>	<b>126,50 €</b>
5G.C4.125	5G.C6.125	999	123	25	C250	cega	<b>192,50 €</b>	<b>225,50 €</b>
5G.C4.125M	5G.C6.125M	499	123	25	C250	cega	<b>110,00 €</b>	<b>137,50 €</b>
5G.PL4.125	5G.PL6.125	999	123	25	A15	perf. L	<b>148,50 €</b>	<b>176,00 €</b>
5G.PL4.125M	5G.PL6.125M	499	123	25	A15	perf. L	<b>88,00 €</b>	<b>99,00 €</b>
5G.PR4.125	5G.PR6.125	999	123	25	B125	perf. R	<b>187,00 €</b>	<b>220,00 €</b>
5G.PR4.125M	5G.PR6.125M	499	123	25	B125	perf. R	<b>104,50 €</b>	<b>121,00 €</b>



Entramada AD  
Ref. 502507

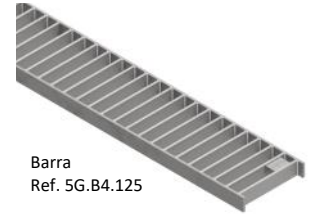

Barra  
Ref. 5G.B4.125

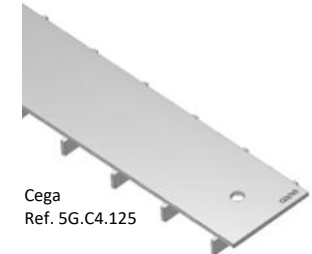

Cega  
Ref. 5G.C4.125



Perfurada  
Ref. 5G.PR4.125

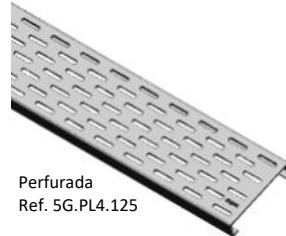

Perfurada  
Ref. 5G.PL4.125

**sifão DN110**

trap DN110

ref		L	H	h água	preço	
<i>aisi304</i>	<i>aisi316</i>				<i>aisi304</i>	<i>aisi316</i>
57A.41.S	57A.61.S	108	99	50	<b>104,50 €</b>	<b>115,50 €</b>



**cesto DN110**

basket DN110

ref		L	H	vol	preço	
<i>aisi304</i>	<i>aisi316</i>			L	<i>aisi304</i>	<i>aisi316</i>
57A.41.C0	57A.61.C0	108	99	-	<b>16,50 €</b>	<b>18,70 €</b>



**corpo sumidouro saída horizontal DN75**

body with horizontal outlet DN75

ref		L	H	DN	preço	
<i>aisi304</i>	<i>aisi316</i>				<i>aisi304</i>	<i>aisi316</i>
57A.41.SH	57A.61.SH	139	155	75	<b>82,50 €</b>	<b>93,50 €</b>



## canal modular sem pendente *Modultek 200*

*modular channel without slope Modultek 200*

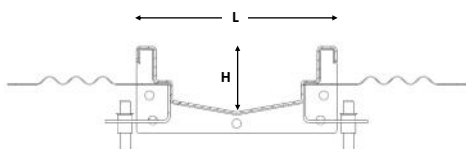

ref		C	L	H1	H2	preço	
<i>aisi304</i>	<i>aisi316</i>					<i>aisi304</i>	<i>aisi316</i>
57.42.0.C2	57.62.0.C2	500	230	65	65	<b>203,50 €</b>	<b>236,50 €</b>
57.42.0.C3	57.62.0.C3	500	230	80	80	<b>214,50 €</b>	<b>253,00 €</b>
57.42.0.C4	57.62.0.C4	500	230	95	95	<b>225,50 €</b>	<b>269,50 €</b>
57.42.0.C5	57.62.0.C5	500	230	110	110	<b>236,50 €</b>	<b>286,00 €</b>
57.42.0.C6	57.62.0.C6	500	230	125	125	<b>247,50 €</b>	<b>302,50 €</b>
57.42.1.C2	57.62.1.C2	1000	230	65	65	<b>253,00 €</b>	<b>308,00 €</b>
57.42.1.C3	57.62.1.C3	1000	230	80	80	<b>269,50 €</b>	<b>330,00 €</b>
57.42.1.C4	57.62.1.C4	1000	230	95	95	<b>286,00 €</b>	<b>352,00 €</b>
57.42.1.C5	57.62.1.C5	1000	230	110	110	<b>302,50 €</b>	<b>374,00 €</b>
57.42.1.C6	57.62.1.C6	1000	230	125	125	<b>319,00 €</b>	<b>396,00 €</b>
57.42.2.C2	57.62.2.C2	2000	230	65	65	<b>385,00 €</b>	<b>484,00 €</b>
57.42.2.C3	57.62.2.C3	2000	230	80	80	<b>412,50 €</b>	<b>517,00 €</b>
57.42.2.C4	57.62.2.C4	2000	230	95	95	<b>440,00 €</b>	<b>550,00 €</b>
57.42.2.C5	57.62.2.C5	2000	230	110	110	<b>467,50 €</b>	<b>583,00 €</b>
57.42.2.C6	57.62.2.C6	2000	230	125	125	<b>495,00 €</b>	<b>616,00 €</b>
57.42.3.C2	57.62.3.C2	3000	230	65	65	<b>495,00 €</b>	<b>632,50 €</b>
57.42.3.C3	57.62.3.C3	3000	230	80	80	<b>528,00 €</b>	<b>676,50 €</b>
57.42.3.C4	57.62.3.C4	3000	230	95	95	<b>561,00 €</b>	<b>720,50 €</b>
57.42.3.C5	57.62.3.C5	3000	230	110	110	<b>583,00 €</b>	<b>764,50 €</b>
57.42.3.C6	57.62.3.C6	3000	230	125	125	<b>616,00 €</b>	<b>808,50 €</b>

## canal modular "L" *Modultek 200*

*modular channel type "L" Modultek 200*

ref		C	L	H1	H2	preço	
<i>aisi304</i>	<i>aisi316</i>					<i>aisi304</i>	<i>aisi316</i>
57.42.0.L2	57.62.0.L2	515	715	65	65	<b>297,00 €</b>	<b>363,00 €</b>
57.42.0.L3	57.62.0.L3	515	715	80	80	<b>319,00 €</b>	<b>385,00 €</b>

## canal modular "T" *Modultek 200*

*modular channel type "T" Modultek 200*

ref		C	L	H1	H2	preço	
<i>aisi304</i>	<i>aisi316</i>					<i>aisi304</i>	<i>aisi316</i>
57.42.0.T2	57.62.0.T2	500	715	65	65	<b>319,00 €</b>	<b>385,00 €</b>
57.42.0.T3	57.62.0.T3	500	715	80	80	<b>341,00 €</b>	<b>418,00 €</b>

## canal modular com pendente Modultek 200

modular channel with slope Modultek 200

ref		C	L	H1	H2	preço	
aisi304	aisi316					aisi304	aisi316
57.42.0.P2	57.62.0.P2	500	230	65	80	<b>214,50 €</b>	<b>264,00 €</b>
57.42.1.P2	57.62.1.P2	1000	230	65	80	<b>280,50 €</b>	<b>341,00 €</b>
57.42.2.P2	57.62.2.P2	2000	230	65	80	<b>423,50 €</b>	<b>528,00 €</b>
57.42.2.P3	57.62.2.P3	2000	230	80	95	<b>451,00 €</b>	<b>561,00 €</b>
57.42.2.P4	57.62.2.P4	2000	230	95	110	<b>478,50 €</b>	<b>594,00 €</b>
57.42.2.P5	57.62.2.P5	2000	230	110	125	<b>506,00 €</b>	<b>627,00 €</b>
57.42.3.P2	57.62.3.P2	3000	230	65	80	<b>539,00 €</b>	<b>682,00 €</b>
57.42.3.P3	57.62.3.P3	3000	230	80	95	<b>572,00 €</b>	<b>726,00 €</b>
57.42.3.P4	57.62.3.P4	3000	230	95	110	<b>605,00 €</b>	<b>770,00 €</b>
57.42.3.P5	57.62.3.P5	3000	230	110	125	<b>638,00 €</b>	<b>814,00 €</b>



## canal modular com saída central Modultek 200

modular channel with central outlet Modultek 200

ref		C	L	H1	DN	preço	
aisi304	aisi316					aisi304	aisi316
57.42.0.SC2	57.62.0.SC2	500	230	65	110	<b>275,00 €</b>	<b>319,00 €</b>
57.42.0.SC3	57.62.0.SC3	500	230	80	110	<b>286,00 €</b>	<b>335,50 €</b>
57.42.0.SC4	57.62.0.SC4	500	230	95	110	<b>297,00 €</b>	<b>352,00 €</b>
57.42.0.SC5	57.62.0.SC5	500	230	110	110	<b>308,00 €</b>	<b>368,50 €</b>
57.42.0.SC6	57.62.0.SC6	500	230	125	110	<b>319,00 €</b>	<b>385,00 €</b>



## canal modular com saída final Modultek 200

modular channel with final outlet Modultek 200

ref		C	L	H1	DN	preço	
aisi304	aisi316					aisi304	aisi316
57.42.1.SF2	57.62.1.SF2	1000	230	65	110	<b>324,50 €</b>	<b>379,50 €</b>
57.42.1.SF3	57.62.1.SF3	1000	230	80	110	<b>341,00 €</b>	<b>401,50 €</b>
57.42.1.SF4	57.62.1.SF4	1000	230	95	110	<b>357,50 €</b>	<b>423,50 €</b>
57.42.1.SF5	57.62.1.SF5	1000	230	110	110	<b>385,00 €</b>	<b>445,50 €</b>
57.42.1.SF6	57.62.1.SF6	1000	230	125	110	<b>401,50 €</b>	<b>467,50 €</b>





## topo fechado Modultek 200

*closed end cap Modultek 200*

ref		C	L	H	DN	preço	
<i>aisi304</i>	<i>aisi316</i>					<i>aisi304</i>	<i>aisi316</i>
57A.42.TF2	57A.62.TF2	15	230	65	-	<b>40,70 €</b>	<b>48,40 €</b>
57A.42.TF3	57A.62.TF3	15	230	80	-	<b>41,80 €</b>	<b>49,50 €</b>
57A.42.TF4	57A.62.TF4	15	230	95	-	<b>42,90 €</b>	<b>50,60 €</b>
57A.42.TF5	57A.62.TF5	15	230	110	-	<b>44,00 €</b>	<b>51,70 €</b>
57A.42.TF6	57A.62.TF6	15	230	125	-	<b>45,10 €</b>	<b>52,80 €</b>



## topo com saída Modultek 200

*open end cap Modultek 200*

ref		C	L	H	DN	preço	
<i>aisi304</i>	<i>aisi316</i>					<i>aisi304</i>	<i>aisi316</i>
57A.42.TS2	57A.62.TS2	15	230	65	50	<b>45,10 €</b>	<b>56,10 €</b>
57A.42.TS3	57A.62.TS3	15	230	80	50	<b>46,20 €</b>	<b>57,20 €</b>
57A.42.TS4	57A.62.TS4	15	230	95	50	<b>47,30 €</b>	<b>58,30 €</b>
57A.42.TS5	57A.62.TS5	15	230	110	50	<b>48,40 €</b>	<b>59,40 €</b>
57A.42.TS6	57A.62.TS6	15	230	125	50	<b>49,50 €</b>	<b>60,50 €</b>



## Junta NBR Modultek 200

*NBR joint Modultek 200*

ref	C	L	H	material	preço
57A.42.J2	15	230	65	NBR	<b>6,60 €</b>
57A.42.J3	15	230	80	NBR	<b>8,250 €</b>
57A.42.J4	15	230	95	NBR	<b>8,80 €</b>
57A.42.J5	15	230	110	NBR	<b>11,00 €</b>
57A.42.J6	15	230	125	NBR	<b>12,650 €</b>

**grelhas Modultek 200**

Modultek 200 gratings

ref		C	L	H	classe	tipo	preço	
<i>aisi304</i>	<i>aisi316</i>						<i>aisi304</i>	<i>aisi316</i>
5G.QA4.200	5G.QA6.200	999	198	25	B125	Entr. AD	<b>176,00 €</b>	<b>214,50 €</b>
5G.QA4.200M	5G.QA6.200M	499	198	25	B125	Entr. AD	<b>110,00 €</b>	<b>137,50 €</b>
5G.B4.200	5G.B6.200	999	198	25	C250	barra	<b>225,50 €</b>	<b>275,00 €</b>
5G.B4.200M	5G.B6.200M	499	198	25	C250	barra	<b>137,50 €</b>	<b>154,00 €</b>
5G.C4.200	5G.C6.200	999	198	25	C250	cega	<b>264,00 €</b>	<b>330,00 €</b>
5G.C4.200M	5G.C6.200M	499	198	25	C250	cega	<b>154,00 €</b>	<b>192,50 €</b>
5G.PL4.200	5G.PL6.200	999	198	25	A15	perf. L	<b>192,50 €</b>	<b>231,00 €</b>
5G.PL4.200M	5G.PL6.200M	499	198	25	A15	perf. L	<b>110,00 €</b>	<b>132,00 €</b>
5G.PR4.200	5G.PR6.200	999	198	25	B125	perf. R	<b>253,00 €</b>	<b>297,00 €</b>
5G.PR4.200M	5G.PR6.200M	499	198	25	B125	perf. R	<b>137,50 €</b>	<b>165,00 €</b>



Entramada AD  
Ref. 502502

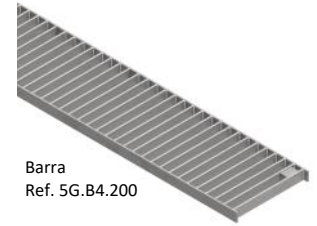

Barra  
Ref. 5G.B4.200

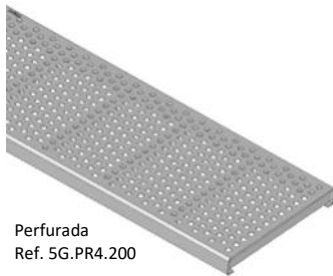

Perfurada  
Ref. 5G.PR4.200



Perfurada  
Ref. 5G.PL4.200

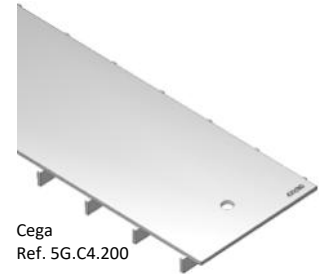

Cega  
Ref. 5G.C4.200

**sifão DN110**

trap DN110

ref		L	H	h água	preço	
<i>aisi304</i>	<i>aisi316</i>				<i>aisi304</i>	<i>aisi316</i>
57A.41.S	57A.61.S	108	99	50	<b>104,50 €</b>	<b>115,50 €</b>



**cesto DN110**

basket DN110

ref		L	H	vol	preço	
<i>aisi304</i>	<i>aisi316</i>			L	<i>aisi304</i>	<i>aisi316</i>
57A.41.C0	57A.61.C0	108	99	-	<b>16,50 €</b>	<b>18,70 €</b>



**corpo sumidouro saída horizontal DN75**

body with horizontal outlet DN75

ref		L	H	DN	preço	
<i>aisi304</i>	<i>aisi316</i>				<i>aisi304</i>	<i>aisi316</i>
57A.41.SH	57A.61.SH	139	155	75	<b>82,50 €</b>	<b>93,50 €</b>



## canal modular sem pendente *SlimLine*

modular channel without slope *SlimLine*

ref		C	L	H1	H2	preço	
<i>aisi304</i>	<i>aisi316</i>					<i>aisi304</i>	<i>aisi316</i>
58.4.0.C1	58.6.0.C1	500	50	75	75	148,50 €	176,00 €
58.4.0.C2	58.6.0.C2	500	50	85	85	154,00 €	181,50 €
58.4.0.C3	58.6.0.C3	500	50	95	95	159,50 €	187,00 €
58.4.0.C4	58.6.0.C4	500	50	105	105	165,00 €	192,50 €
58.4.0.C5	58.6.0.C5	500	50	115	115	170,50 €	198,00 €
58.4.0.C6	58.6.0.C6	500	50	125	125	176,00 €	203,50 €
58.4.1.C1	58.6.1.C1	1000	50	75	75	181,50 €	220,00 €
58.4.1.C2	58.6.1.C2	1000	50	85	85	192,50 €	231,00 €
58.4.1.C3	58.6.1.C3	1000	50	95	95	203,50 €	242,00 €
58.4.1.C4	58.6.1.C4	1000	50	105	105	214,50 €	253,00 €
58.4.1.C5	58.6.1.C5	1000	50	115	115	225,50 €	264,00 €
58.4.1.C6	58.6.1.C6	1000	50	125	125	236,50 €	275,00 €
58.4.2.C1	58.6.2.C1	2000	50	75	75	264,00 €	330,00 €
58.4.2.C2	58.6.2.C2	2000	50	85	85	275,00 €	346,50 €
58.4.2.C3	58.6.2.C3	2000	50	95	95	286,00 €	363,00 €
58.4.2.C4	58.6.2.C4	2000	50	105	105	297,00 €	379,50 €
58.4.2.C5	58.6.2.C5	2000	50	115	115	308,00 €	396,00 €
58.4.2.C6	58.6.2.C6	2000	50	125	125	330,00 €	412,50 €
58.4.3.C1	58.6.3.C1	3000	50	75	75	324,50 €	434,50 €
58.4.3.C2	58.6.3.C2	3000	50	85	85	341,00 €	456,50 €
58.4.3.C3	58.6.3.C3	3000	50	95	95	357,50 €	478,50 €
58.4.3.C4	58.6.3.C4	3000	50	105	105	374,00 €	500,50 €
58.4.3.C5	58.6.3.C5	3000	50	115	115	390,50 €	522,50 €
58.4.3.C6	58.6.3.C6	3000	50	125	125	407,00 €	544,50 €

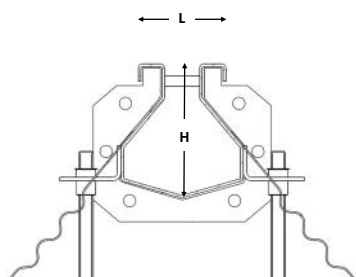

## canal modular "L" *SlimLine*

modular channel type "L" *SlimLine*

ref		C	L	H1	H2	preço	
<i>aisi304</i>	<i>aisi316</i>					<i>aisi304</i>	<i>aisi316</i>
58.4.0.L1	58.6.0.L1	500	500	75	75	209,00 €	258,50 €
58.4.0.L2	58.6.0.L2	500	500	85	85	220,00 €	269,50 €



## canal modular "T" *SlimLine*

modular channel type "T" *SlimLine*

ref		C	L	H1	H2	preço	
<i>aisi304</i>	<i>aisi316</i>					<i>aisi304</i>	<i>aisi316</i>
58.4.0.T1	58.6.0.T1	500	500	75	75	242,00 €	275,00 €
58.4.0.T2	58.6.0.T2	500	500	85	85	253,00 €	297,00 €

**canal modular com pendente SlimLine***modular channel with slope SlimLine*

ref		C	L	H1	H2	preço	
<i>aisi304</i>	<i>aisi316</i>					<i>aisi304</i>	<i>aisi316</i>
58.4.0.P1	58.6.0.P1	500	50	75	85	<b>159,50 €</b>	<b>176,00 €</b>
58.4.0.P2	58.6.0.P2	500	50	85	95	<b>165,00 €</b>	<b>187,00 €</b>
58.4.1.P1	58.6.1.P1	1000	50	75	85	<b>198,00 €</b>	<b>236,50 €</b>
58.4.1.P2	58.6.1.P2	1000	50	85	95	<b>209,00 €</b>	<b>247,50 €</b>
58.4.2.P1	58.6.2.P1	2000	50	75	85	<b>280,50 €</b>	<b>357,50 €</b>
58.4.2.P2	58.6.2.P2	2000	50	85	95	<b>302,50 €</b>	<b>374,00 €</b>
58.4.2.P3	58.6.2.P3	2000	50	95	105	<b>324,50 €</b>	<b>390,50 €</b>
58.4.2.P4	58.6.2.P4	2000	50	105	115	<b>346,50 €</b>	<b>407,00 €</b>
58.4.2.P5	58.6.2.P5	2000	50	115	125	<b>368,50 €</b>	<b>423,50 €</b>
58.4.3.P1	58.6.3.P1	3000	50	75	85	<b>352,00 €</b>	<b>467,50 €</b>
58.4.3.P2	58.6.3.P2	3000	50	85	95	<b>379,50 €</b>	<b>489,50 €</b>
58.4.3.P3	58.6.3.P3	3000	50	95	105	<b>407,00 €</b>	<b>511,50 €</b>
58.4.3.P4	58.6.3.P4	3000	50	105	115	<b>434,50 €</b>	<b>533,50 €</b>
58.4.3.P5	58.6.3.P5	3000	50	115	125	<b>462,00 €</b>	<b>555,50 €</b>

**canal modular com saída central SlimLine***modular channel with central outlet SlimLine*

ref		C	L	H	DN	preço	
<i>aisi304</i>	<i>aisi316</i>					<i>aisi304</i>	<i>aisi316</i>
58.4.0.SC1	58.6.0.SC1	500	50	75	110	<b>231,00 €</b>	<b>275,00 €</b>
58.4.0.SC2	58.6.0.SC2	500	50	85	110	<b>236,50 €</b>	<b>280,50 €</b>
58.4.0.SC3	58.6.0.SC3	500	50	95	110	<b>242,00 €</b>	<b>286,00 €</b>
58.4.0.SC4	58.6.0.SC4	500	50	105	110	<b>247,50 €</b>	<b>291,50 €</b>
58.4.0.SC5	58.6.0.SC5	500	50	115	110	<b>253,00 €</b>	<b>297,00 €</b>
58.4.0.SC6	58.6.0.SC6	500	50	125	110	<b>258,50 €</b>	<b>302,50 €</b>

**canal modular com saída final SlimLine***modular channel with final outlet SlimLine*

ref		C	L	H	DN	preço	
<i>aisi304</i>	<i>aisi316</i>					<i>aisi304</i>	<i>aisi316</i>
58.4.1.SF1	58.6.1.SF1	1000	50	75	110	<b>258,50 €</b>	<b>313,50 €</b>
58.4.1.SF2	58.6.1.SF2	1000	50	85	110	<b>269,50 €</b>	<b>324,50 €</b>
58.4.1.SF3	58.6.1.SF3	1000	50	95	110	<b>280,50 €</b>	<b>335,50 €</b>
58.4.1.SF4	58.6.1.SF4	1000	50	105	110	<b>291,50 €</b>	<b>346,50 €</b>
58.4.1.SF5	58.6.1.SF5	1000	50	115	110	<b>302,50 €</b>	<b>357,50 €</b>
58.4.1.SF6	58.6.1.SF6	1000	50	125	110	<b>313,50 €</b>	<b>368,50 €</b>



# Inox



## topo fechado SlimLine

closed end cap SlimLine

ref		C	L	H	DN	preço	
aisi304	aisi316					aisi304	aisi316
58A.4.TF1	58A.6.TF1	15	50	75	-	<b>31,90 €</b>	<b>35,20 €</b>
58A.4.TF2	58A.6.TF2	15	50	85	-	<b>33,00 €</b>	<b>36,30 €</b>
58A.4.TF3	58A.6.TF3	15	50	95	-	<b>34,10 €</b>	<b>37,40 €</b>
58A.4.TF4	58A.6.TF4	15	50	105	-	<b>35,20 €</b>	<b>38,50 €</b>
58A.4.TF5	58A.6.TF5	15	50	115	-	<b>36,30 €</b>	<b>39,60 €</b>
58A.4.TF6	58A.6.TF6	15	50	125	-	<b>37,40 €</b>	<b>40,70 €</b>

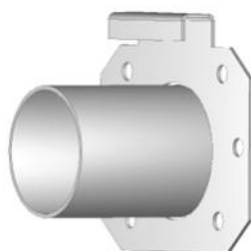

## topo com saída SlimLine

open end cap SlimLine

ref		C	L	H	DN	preço	
aisi304	aisi316					aisi304	aisi316
58A.4.TS1	58A.6.TS1	15	50	75	50	<b>37,40 €</b>	<b>41,80 €</b>
58A.4.TS2	58A.6.TS2	15	50	85	50	<b>38,50 €</b>	<b>42,90 €</b>
58A.4.TS3	58A.6.TS3	15	50	95	50	<b>39,60 €</b>	<b>44,00 €</b>
58A.4.TS4	58A.6.TS4	15	50	105	50	<b>40,70 €</b>	<b>45,10 €</b>
58A.4.TS5	58A.6.TS5	15	50	115	50	<b>41,80 €</b>	<b>46,20 €</b>
58A.4.TS6	58A.6.TS6	15	50	125	50	<b>42,90 €</b>	<b>47,30 €</b>



## Junta NBR SlimLine

NBR joint SlimLine

ref	C	L	H	material	preço
58A.4.J1	15	50	75	NBR	<b>3,30 €</b>
58A.4.J2	15	50	85	NBR	<b>3,850 €</b>
58A.4.J3	15	50	95	NBR	<b>4,950 €</b>
58A.4.J4	15	50	105	NBR	<b>4,950 €</b>
58A.4.J5	15	50	115	NBR	<b>6,050 €</b>
58A.4.J6	15	50	125	NBR	<b>6,60 €</b>

**grelhas SlimLine**

*SlimLine gratings*

ref		C	L	H	classe	tipo	preço	
<i>aisi304</i>	<i>aisi316</i>						<i>aisi304</i>	<i>aisi316</i>
5G.B4.200Q	5G.B6.200Q	198	198	25	C250	barra	<b>77,00 €</b>	<b>88,00 €</b>
5G.C4.200Q	5G.C6.200Q	198	198	25	C250	cega	<b>82,50 €</b>	<b>93,50 €</b>
5G.PL4.200Q	5G.PL6.200	198	198	25	A15	perf. L	<b>49,50 €</b>	<b>60,50 €</b>



Perfurada  
Ref. 5G.PL4.200

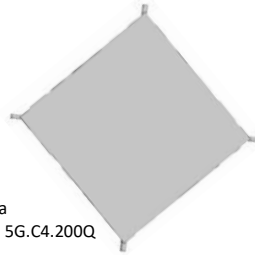

Cega  
Ref. 5G.C4.200Q



Barra  
Ref. 5G.B4.200Q

**sifão DN110**

*trap DN110*

ref		L	H	h água	preço	
<i>aisi304</i>	<i>aisi316</i>				<i>aisi304</i>	<i>aisi316</i>
57A.41.S	57A.61.S	108	99	50	<b>104,50 €</b>	<b>115,50 €</b>



**cesto DN110**

*basket DN110*

ref		L	H	vol	preço	
<i>aisi304</i>	<i>aisi316</i>			<i>L</i>	<i>aisi304</i>	<i>aisi316</i>
57A.41.C0	57A.61.C0	108	99	-	<b>16,50 €</b>	<b>18,70 €</b>



**corpo sumidouro saída horizontal DN75**

*body with horizontal outlet DN75*

ref		L	H	DN	preço	
<i>aisi304</i>	<i>aisi316</i>				<i>aisi304</i>	<i>aisi316</i>
57A.41.SH	57A.61.SH	139	155	75	<b>82,50 €</b>	<b>93,50 €</b>



# Inox

**b125**



## quadriculadas

*Mesh gratings*

ref	comp.	larg.	altura	classe	material	preço
	<i>length</i>	<i>width</i>	<i>height</i>	<i>class</i>		<i>price</i>
502.10.IN	1000	98	25	B125	AISI 304	<b>121,00 €</b>
502.15.IN	1000	148	25	B125	AISI 304	<b>132,00 €</b>
502.20.IN	1000	198	25	B125	AISI 304	<b>143,00 €</b>
502.25.IN	1000	248	25	B125	AISI 304	<b>154,00 €</b>

**a15**



## estampadas

*slotted / perforated gratings*

ref	comp.	larg.	altura	classe	material	preço
	<i>length</i>	<i>width</i>	<i>height</i>	<i>class</i>		<i>price</i>
501.10.IN	1000	100	25	A15	AISI 304	<b>33,00 €</b>
501.15.IN	1000	150	25	A15	AISI 304	<b>44,00 €</b>
501.20.IN	1000	200	25	A15	AISI 304	<b>55,00 €</b>
501.25.IN	1000	250	25	A15	AISI 304	<b>66,00 €</b>



## aros

*frames*

ref	comp.	larg.	altura	classe	material	preço
	<i>length</i>	<i>width</i>	<i>height</i>	<i>class</i>		<i>price</i>
503A.10.IN	1000	100	25	A15	AISI 304	<b>33,00 €</b>
503A.15.IN	1000	150	25	A15	AISI 304	<b>38,50 €</b>
503A.20.IN	1000	200	25	A15	AISI 304	<b>44,00 €</b>
503A.25.IN	1000	250	25	A15	AISI 304	<b>49,50 €</b>

**estanque rebaixada alumínio Alutec**

sealed Recessed covers Alutec



ref	mod.	ab. útil	altura	classe	material	preço
		<i>open clear</i>	<i>height</i>	<i>class</i>		<i>price</i>
520.300	300	216x216	55 (40)	A15	Alum.	<b>110,00 €</b>
520.400	400	316x316	55 (40)	A15	Alum.	<b>148,50 €</b>
520.500	500	416x416	55 (40)	A15	Alum.	<b>170,50 €</b>
520.600	600	516x516	55 (40)	A15	Alum.	<b>209,00 €</b>
520.700	700	616x616	55 (40)	A15	Alum.	<b>247,50 €</b>
520.800	800	716x716	55 (40)	A15	Alum.	<b>302,50 €</b>
520.900	900	816x816	55 (40)	A15	Alum.	<b>363,00 €</b>

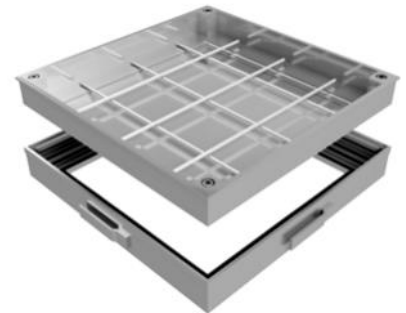

**estanque rasa inox Guard 304**

sealed solid top covers Guard 304



ref	mod.	ab. útil	altura	classe	material	preço
		<i>open clear</i>	<i>height</i>	<i>class</i>		<i>price</i>
555.R0.30	300	200x200	70	B125	AISI 304	<b>330,00 €</b>
555.R0.40	400	300x300	70	B125	AISI 304	<b>429,00 €</b>
555.R0.50	500	400x400	70	B125	AISI 304	<b>572,00 €</b>
555.R0.60	600	500x500	70	B125	AISI 304	<b>748,00 €</b>
555.R0.70	700	600x600	70	A15	AISI 304	<b>935,00 €</b>
555.R0.80	800	700x700	70	A15	AISI 304	<b>1 155,00 €</b>



**estanque rebaixada inox Guard 304**

sealed recessed covers Guard 304



ref	mod.	ab. útil	altura	classe	material	preço
		<i>open clear</i>	<i>height</i>	<i>class</i>		<i>price</i>
555.R5.30	300	200x200	70 (50)	C250	AISI 304	<b>231,00 €</b>
555.R5.40	400	300x300	70 (50)	C250	AISI 304	<b>280,50 €</b>
555.R5.50	500	400x400	70 (110)	C250	AISI 304	<b>385,00 €</b>
555.R5.60	600	500x500	70 (110)	C250	AISI 304	<b>440,00 €</b>
555.R5.70	700	600x600	70 (150)	C250	AISI 304	<b>566,50 €</b>
555.R5.80	800	700x700	70 (150)	C250	AISI 304	<b>654,50 €</b>



**estanque rebaixada inox Guard 316**

sealed recessed covers Guard 316



ref	mod.	ab. útil	altura	classe	material	preço
		<i>open clear</i>	<i>height</i>	<i>class</i>		<i>price</i>
556.R5.30	300	200x200	70 (50)	C250	AISI 316	<b>275,00 €</b>
556.R5.40	400	300x300	70 (50)	C250	AISI 316	<b>341,00 €</b>
556.R5.50	500	400x400	70 (110)	C250	AISI 316	<b>473,00 €</b>
556.R5.60	600	500x500	70 (110)	C250	AISI 316	<b>561,00 €</b>
556.R5.70	700	600x600	70 (150)	C250	AISI 316	<b>737,00 €</b>
556.R5.80	800	700x700	70 (150)	C250	AISI 316	<b>847,00 €</b>

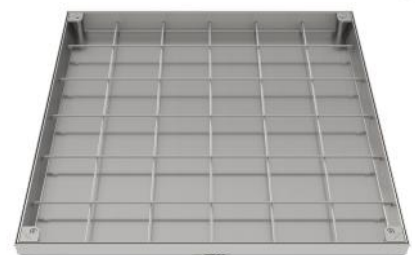

# Inox

C250

## rebaixada inox Hydra 304

recessed covers Hydra 304

ref	mod.	ab. útil	altura	classe	material	preço
		<i>open clear</i>	<i>height</i>	<i>class</i>		<i>price</i>
550.R3.30	300	200x200	39 / 25	A15	AISI 304	<b>110,00 €</b>
550.R3.40	400	300x300	39 / 25	A15	AISI 304	<b>137,50 €</b>
550.R3.50	500	400x400	39 / 25	A15	AISI 304	<b>170,50 €</b>
550.R3.60	600	500x500	39 / 25	A15	AISI 304	<b>203,50 €</b>
550.R3.70	700	600x600	39 / 25	A15	AISI 304	<b>297,00 €</b>
550.R5.50	500	400x400	65 / 50	B125	AISI 304	<b>203,50 €</b>
550.R5.60	600	500x500	65 / 50	B125	AISI 304	<b>247,50 €</b>
550.R8.70	700	600x600	90 / 75	B125	AISI 304	<b>396,00 €</b>
550.R8.80	800	700x700	90 / 75	B125	AISI 304	<b>467,50 €</b>
550.R5.40	400	300x300	65 / 50	C250	AISI 304	<b>165,00 €</b>
550.R8.50	500	400x400	90 / 75	C250	AISI 304	<b>231,00 €</b>
550.R8.60	600	500x500	90 / 75	C250	AISI 304	<b>275,00 €</b>
550.R8.70R	700	600x600	90 / 75	C250	AISI 304	<b>478,50 €</b>
550.R8.80R	800	700x700	90 / 75	C250	AISI 304	<b>572,00 €</b>



Vedação  
Hidráulica



C250

## rebaixada inox Hydra 316

recessed covers Hydra 316

ref	mod.	ab. útil	altura	classe	material	preço
		<i>open clear</i>	<i>height</i>	<i>class</i>		<i>price</i>
551.R3.30	300	200x200	39 / 25	A15	AISI 316	<b>137,50 €</b>
551.R3.40	400	300x300	39 / 25	A15	AISI 316	<b>176,00 €</b>
551.R3.50	500	400x400	39 / 25	A15	AISI 316	<b>220,00 €</b>
551.R3.60	600	500x500	39 / 25	A15	AISI 316	<b>269,50 €</b>
551.R3.70	700	600x600	39 / 25	A15	AISI 316	<b>396,00 €</b>
551.R5.50	500	400x400	65 / 50	B125	AISI 316	<b>275,00 €</b>
551.R5.60	600	500x500	65 / 50	B125	AISI 316	<b>330,00 €</b>
551.R8.70	700	600x600	90 / 75	B125	AISI 316	<b>550,00 €</b>
551.R8.80	800	700x700	90 / 75	B125	AISI 316	<b>638,00 €</b>
551.R5.40	400	300x300	65 / 50	C250	AISI 316	<b>220,00 €</b>
551.R8.50	500	400x400	90 / 75	C250	AISI 316	<b>297,00 €</b>
551.R8.60	600	500x500	90 / 75	C250	AISI 316	<b>374,00 €</b>
551.R8.70R	700	600x600	90 / 75	C250	AISI 316	<b>632,50 €</b>
551.R8.80R	800	700x700	90 / 75	C250	AISI 316	<b>742,50 €</b>



Vedação  
Hidráulica



**estanque rebaixada GUARD***sealed recessed covers GUARD*

b125

ref	mod.	ab. útil	altura	classe	un	preço
515.R5.30	300	200x200	70	C250	20	99,00 €
515.R5.40	400	300x300	70	C250	20	115,50 €
515.R5.50	500	400x400	70	B125	20	137,50 €
515.R5.60	600	500x500	70	B125	10	170,50 €
515.R5.70	700	600x600	70	A15	10	220,00 €
515.R5.80	800	700x700	70	A15	10	269,50 €

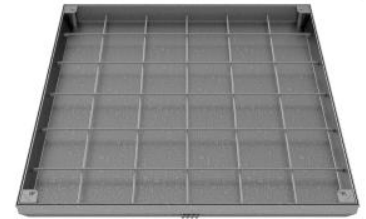
**estanque rebaixada GUARD Plus***sealed recessed covers GUARD Plus*

C250

ref	mod.	ab. útil	altura	classe	un	preço
516.R5.C.50	500	400x400	70 / 101	C250	20	242,00 €
516.R5.C.60	600	500x500	70 / 101	C250	10	330,00 €
516.R5.C.70	700	600x600	70 / 111	C250	10	412,50 €



nota: Galvanizada a quente

**estanque rebaixada GUARD Plus***sealed recessed covers GUARD Plus*

d400

ref	mod.	ab. útil	altura	classe	un	preço
516.R5.D.50	500	400x300	70 / 135	D400	20	385,00 €
516.R5.D.60	600	500x400	70 / 135	D400	10	550,00 €
516.R5.D.70	700	600x500	70 / 135	D400	10	715,00 €



nota: Galvanizada a quente

**abertura assistida rebaixada GUARD Assist***assisted opning recessed covers GUARD Assist*

a15

ref	mod.	ab. útil	altura	classe	un	preço
517.90	900	800x800	80 + 100	A15	10	990,00 €
517.100	1000	900x900	80 + 100	A15	10	1 072,50 €
517.110	1100	1000x1000	80 + 100	A15	10	1 155,00 €

nota: Galvanizada a quente



# galvanizado



Vedação  
Hidráulica

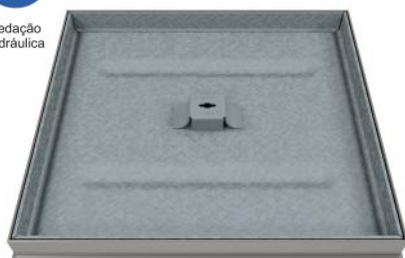

**b125**

## rebaixada 25 HydraPlus

*HydraPlus recessed covers 25*

ref	mod.	ab. útil	altura	classe	un	preço
511.R3.30	300	200x200	39	B125	60	<b>34,10 €</b>
511.R3.40	400	300x300	39	B125	60	<b>48,40 €</b>
511.R3.50	500	400x400	39	A15	60	<b>71,50 €</b>
511.R3.60	600	500x500	39	A15	60	<b>88,00 €</b>
511.R3.70	700	600x600	39	A15	20	<b>115,50 €</b>
511.R3.80	800	700x700	39	A15	20	<b>143,00 €</b>



Vedação  
Hidráulica

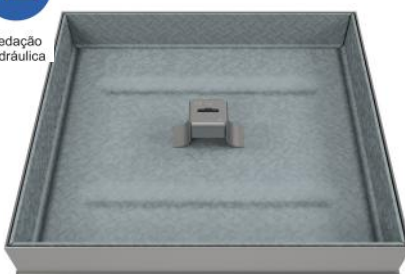

**C250**

## rebaixada 50 HydraPlus

*HydraPlus recessed covers 50*

ref	mod.	ab. útil	altura	classe	un	preço
511.R5.30	300	200x200	65	C250	60	<b>44,00 €</b>
511.R5.40	400	300x300	65	C250	60	<b>61,60 €</b>
511.R5.50	500	400x400	65	B125	60	<b>81,40 €</b>
511.R5.60	600	500x500	65	B125	60	<b>105,60 €</b>
511.R5.70	700	600x600	65	B125	20	<b>137,50 €</b>
511.R5.80	800	700x700	65	B125	20	<b>170,50 €</b>



Vedação  
Hidráulica



**C250**

## rebaixada 75 HydraPlus

*HydraPlus recessed covers 75*

ref	mod.	ab. útil	altura	classe	un	preço
511.R8.40	400	300x300	90	C250	60	<b>72,60 €</b>
511.R8.50	500	400x400	90	C250	60	<b>94,60 €</b>
511.R8.60	600	500x500	90	C250	60	<b>121,00 €</b>
511.R8.70	700	600x600	90	C250	20	<b>170,50 €</b>



Vedação  
Hidráulica



**A15**

## rasa HydraPlus

*HydraPlus solid top covers*

ref	mod.	ab. útil	altura	classe	un	preço
511.R0.30	300	200x200	39	A15	60	<b>30,80 €</b>
511.R0.40	400	300x300	39	A15	60	<b>46,20 €</b>
511.R0.50	500	400x400	39	A15	60	<b>63,80 €</b>
511.R0.60	600	500x500	39	A15	60	<b>84,70 €</b>
511.R0.70	700	600x600	39	A15	20	<b>115,50 €</b>
511.R0.80	800	700x700	39	A15	20	<b>148,50 €</b>
511.R0.90	900	800x800	39	A15	20	<b>176,00 €</b>

**rebaixada 25 Hydra***recessed covers Hydra 25*

A15

ref	mod.	ab. útil	altura	classe	un	preço
510.R3.30	300	200x200	39	A15	60	19,80 €
510.R3.40	400	300x300	39	A15	60	25,30 €
510.R3.50	500	400x400	39	A15	60	33,00 €
510.R3.60	600	500x500	39	A15	60	41,80 €
510.R3.70	700	600x600	39	A15	20	69,30 €
510.R3.80	800	700x700	39	A15	20	83,60 €

Vedação  
Hidráulica**rebaixada 50 Hydra***recessed covers Hydra 50*

B125

ref	mod.	ab. útil	altura	classe	un	preço
510.R5.30	300	200x200	65	B125	60	25,30 €
510.R5.40	400	300x300	65	B125	60	33,00 €
510.R5.50	500	400x400	65	B125	60	41,80 €
510.R5.60	600	500x500	65	B125	60	52,80 €
510.R5.70	700	600x600	65	A15	20	80,30 €
510.R5.80	800	700x700	65	A15	20	94,60 €

Vedação  
Hidráulica**rebaixada 75 Hydra***recessed covers Hydra 75*

B125

ref	mod.	ab. útil	altura	classe	un	preço
510.R8.40	400	300x300	90	C250	60	60,50 €
510.R8.50	500	400x400	90	C250	60	79,20 €
510.R8.60	600	500x500	90	C250	60	93,50 €
510.R8.70	700	600x600	90	B125	20	117,70 €

Vedação  
Hidráulica**rasa Hydra***solid top covers Hydra*

A15

ref	mod.	ab. útil	altura	classe	un	preço
510.R0.30	300	200x200	39	A15	60	20,90 €
510.R0.40	400	300x300	39	A15	60	29,70 €
510.R0.50	500	400x400	39	A15	60	40,70 €
510.R0.60	600	500x500	39	A15	60	52,80 €
510.R0.70	700	600x600	39	A15	20	80,30 €

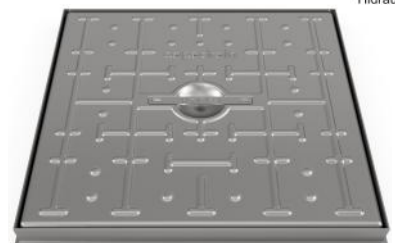
Vedação  
Hidráulica

# galvanizado



Vedação  
Hidráulica

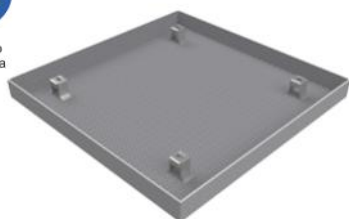

C250

## rebaixada 75 Xadrez

*Xadrez recessed covers 75*

ref	mod.	ab. útil	altura	classe	un	preço
505.R8.90	900	800x800	90	A15	10	<b>247,50 €</b>
505.R8.100	1000	900x900	90	A15	10	<b>286,00 €</b>
505.R8.90R	900R	800x800	90/150	C250	10	<b>495,00 €</b>
505.R8.100R	1000R	900x900	90/150	C250	10	<b>575,00 €</b>
505.R8.110R	1100R	1000x1000	90/150	B125	10	<b>690,00 €</b>



b125

## rebaixada NR

*NR type recessed filled covers*

ref	mod.	ab. útil	altura	classe	un	preço
505M.NR1	700x850	600x750	60	B125	20	<b>198,00 €</b>
505M.NR2	1300x850	1200x750	60	B125	20	<b>324,50 €</b>
505M.NR3	1600x850	1500x750	60	B125	20	<b>396,00 €</b>

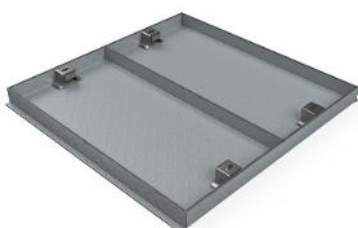

b125

## rebaixada armário BT

*cabinet covers BT*

ref	mod.	ab. útil	altura	classe	un	preço
505M.AR1	840x800	800x700	60	B125	20	<b>192,50 €</b>
505M.AR2	840x1100	800x1000	60	B125	20	<b>242,00 €</b>



## alçapão

*trapdoor*

ref	mod.	ab. útil	altura	tipo	un	preço
506.50	500	470x470	40	ligeiro	60	<b>45,10 €</b>
506.60	600	570x570	40	ligeiro	60	<b>55,00 €</b>
506.50R	500	470x470	40	reforçado	60	<b>77,00 €</b>
506.60R	600	570x570	40	reforçado	60	<b>96,80 €</b>

## acessórios tampas de visita

*accessories manhole covers*

ref	descrição	preço
508701	Chave de Manobra em "T" c/ 25cm	<b>11,00 €</b>
508703	KIT chaves para modelos Estanques	<b>16,50 €</b>

**grelhas estampadas***slotted gratings*

A15

ref	comp.	larg.	altura	classe	un	preço
501.10.G	1000	100	25	A15	300	9,02 €
501.15.G	1000	150	25	A15	300	10,45 €
501.20.G	1000	200	25	A15	300	15,40 €
501.25.G	1000	250	25	A15	200	18,15 €

**grelhas estampadas reforçadas***slotted gratings reinforced*

A15

ref	comp.	larg.	altura	classe	un	preço
501.10.GR	1000	100	25	A15	300	16,50 €
501.15.GR	1000	150	25	A15	300	20,90 €
501.20.GR	1000	200	25	A15	300	25,30 €
501.25.GR	1000	250	25	A15	200	30,25 €

**grelhas estampadas Capa Self***slotted gratings Capa Self*

A15

ref	comp.	larg.	altura	classe	un	preço
501.10.CS	1000	125	-	A15	200	12,10 €
501.15.CS	1000	150	-	A15	200	13,75 €

**aros***frames*

ref	comp.	larg.	altura	classe	un	preço
503A.10.G	1000	100	25	-	100	11,00 €
503A.15.G	1000	150	25	-	100	11,55 €
503A.20.G	1000	200	25	-	100	11,88 €
503A.25.G	1000	250	25	-	100	12,10 €
503A.10.GR	1000	100	40	-	100	13,31 €
503A.15.GR	1000	150	40	-	100	13,97 €
503A.20.GR	1000	200	40	-	100	14,63 €
503A.25.GR	1000	250	40	-	100	15,40 €



# galvanizado



## quadriculadas 30x30

mesh gratings 30x30

ref	comp.	larg.	altura	classe	un	preço
<b>Normal</b>						
502.10.G	1000	100	25	A15	50	16,50 €
502.15.G	1000	150	25	A15	50	23,10 €
502.20.G	1000	200	25	A15	50	28,60 €
502.25.G	1000	250	25	A15	50	35,20 €
502.50.G	1000	500	25	A15	50	64,90 €
<b>Reforçada</b>						
502.10.GR	1000	100	40	B125	50	24,20 €
502.15.GR	1000	150	40	B125	50	36,30 €
502.20.GR	1000	200	40	B125	50	46,20 €
502.25.GR	1000	250	40	A15	50	55,00 €
502.50.GR	1000	500	40	A15	50	101,20 €
502.100.GR *	1000	500	40	A15	50	110,00 €

\* montante a 1000



## quadriculadas 40x20

mesh gratings 40x20

ref	comp.	larg.	altura	classe	un	preço
502.10.GR2	1000	100	40	B125	50	39,60 €
502.15.GR2	1000	150	40	B125	50	47,30 €
502.20.GR2	1000	200	40	B125	50	58,30 €
502.25.GR2	1000	250	40	B125	50	68,20 €
502.50.GR2	1000	500	40	A15	50	124,30 €



## quadriculadas com aro 30x30

mesh gratings with frame

ref	comp.	larg.	altura	classe	un	preço
<b>Normal</b>						
502.20Q.G	200	200	25	A15	50	14,30 €
502.25Q.G	250	250	25	A15	50	18,70 €
502.30Q.G	300	300	25	A15	50	22,00 €
502.35Q.G	350	350	25	A15	50	27,50 €
502.40Q.G	400	400	25	A15	50	33,00 €
502.45Q.G	450	450	25	A15	50	39,60 €
502.50Q.G	500	500	25	A15	50	46,20 €
502.55Q.G	550	550	25	A15	50	55,00 €
<b>Reforçada</b>						
502.35Q.GR	350	350	40	A15	50	39,60 €
502.45Q.GR	450	450	40	A15	50	58,30 €
502.55Q.GR	550	550	40	A15	50	81,40 €



## canais Self Kit 100

Self kit 100 channels

ref	comp.	larg.	altura	grelha	un	preço
	length	width	height	grating	pallet	price
93SF.EUROKIT	1000	120	85	Passar.	108	<b>29,15 €</b>
93SF.ESELFKIT	1000	127	95	Passar.	96	<b>30,80 €</b>



## canais Self

Self channels

ref	comp.	larg.	altura	self	un	preço
	length	width	height		pallet	price
93RS.100.50R	1000	125	50	100	120	<b>18,15 €</b>
93RS.100.75R	1000	125	75	100	120	<b>23,65 €</b>
93RS.100.100R	1000	125	100	100	105	<b>26,40 €</b>
93RS.100.125R	1000	125	125	100	120	<b>31,35 €</b>
93RS.100.150R	1000	125	150	100	90	<b>35,75 €</b>
93RS.150.75R	1000	175	75	200	75	<b>35,20 €</b>
93RS.150.150R	1000	175	150	200	54	<b>43,45 €</b>
93SF.250	1000	260	155	250	35	<b>69,80 €</b>
93SF.300	1000	300	190	300	35	<b>70,90 €</b>



## grelhas Self

Self gratings

ref	descrição	mater.	classe	preço
	description	material	class	price
93GRS.100.GP.A	Grelha Pass. 100 - 1m RapidSelf	Galv.	A15	<b>13,20 €</b>
93GRS.100.IP.A	Grelha Pass. 100 - 1m RapidSelf	Inox	A15	<b>44,00 €</b>
93GRS.100.GQ.B	Grelha Entram. 100 - 1m RapidSelf	Galv.	B125	<b>41,25 €</b>
93GRS.100.FP.B	Grelha FF 100 - 0.5m RapidSelf	FF	B125	<b>17,05 €</b>
93GRS.100.FP.C	Grelha FF 100 - 0.5m RapidSelf	FF	C250	<b>22,00 €</b>
93GE.100.GR.C	Grelha Ranhurada 100 - 1m	Galv.	C250	<b>48,95 €</b>
93GRS.150.GP.A	Grelha Pass. 150 - 1m RapidSelf	Galv.	A15	<b>23,10 €</b>
93GRS.150.GQ.B	Grelha Entram. 150 - 1m RapidSelf	Galv.	B125	<b>59,40 €</b>
93GRS.150.FP.B	Grelha FF 150 - 0.5m RapidSelf	FF	B125	<b>28,05 €</b>
93GRS.150.FP.C	Grelha FF 150 - 0.5m RapidSelf	FF	C250	<b>31,90 €</b>
93GE.150.GR.C	Grelha Ranhurada 150 - 1m	Galv.	C250	<b>62,70 €</b>
93GE.200.GP.A	Grelha Pass. 200 - 1m + Fix	Galv.	A15	<b>70,95 €</b>
93GE.200.GQ33.B	Grelha Entram. 200 - 1m + Fix	Galv.	B125	<b>89,10 €</b>
93GE.200.FP.C	Grelha FF 200 - 0.5m + Fix	250	C250	<b>58,30 €</b>
93GE.250.GQ.B	Grelha Entram. Galv.250 - 1m + Fix	300	B125	<b>172,15 €</b>
93GE.250.FP.B	Grelha FF 250 - 0.5m + Fix	300	B125	<b>74,25 €</b>
93GE.250.FP.C	Grelha FF 250 - 0.5m + Fix	300	C250	<b>91,30 €</b>

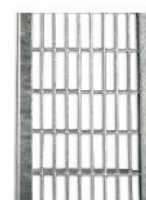

## betão polímero

### canal Ecoplast 100

Ecoplast channels

ref	comp.	larg.	altura	grelha	un	preço
	<i>length</i>	<i>width</i>	<i>height</i>	<i>grating</i>	<i>pallet</i>	<i>price</i>
925.GALV	1000	125	80	passar. galv.	135	<b>17,05 €</b>
925.PLAST	1000	125	80	passar. PP	135	<b>15,40 €</b>
925.LINE	1000	125	80	line PP	135	<b>19,25 €</b>

### canal Plast 100

Plast 100 channels

ref	comp.	larg.	altura	grelha	un	preço
	<i>length</i>	<i>width</i>	<i>height</i>	<i>grating</i>	<i>pallet</i>	<i>price</i>
925200	1000	138	134	passar. galv.	48	<b>23,65 €</b>
925300	1000	130	65	passar. galv.	120	<b>20,35 €</b>

### canal Self K

Self K channels

ref	comp.	larg.	altura	self K	un	preço
	<i>length</i>	<i>width</i>	<i>height</i>		<i>pallet</i>	<i>price</i>
93SF.100K	1000	130	100	100	105	<b>47,30 €</b>
93SF.200K	1000	204	162	200	54	<b>80,30 €</b>
93SF.250K	1000	260	180	250	35	<b>102,85 €</b>
93SF.350K	1000	360	210	300	25	<b>124,30 €</b>

### grelhas Self K

Self K gratings

ref	descrição	classe	self K	preço
	<i>description</i>	<i>class</i>		<i>price</i>
93GK.100K.GP.A	Grelha Pass. Galv. 100 - 1m + Fix	A15	100K	<b>18,70 €</b>
93GK.100K.GQ.B	Grelha Entram. Galv.100 -1m + Fix	B125	100K	<b>45,10 €</b>
93GK.100K.GPR.A	Grelha Perf. Galv.100 - 1m + Fix	A15	100K	<b>17,60 €</b>
93GK.100K.FP.C	Grelha FF 100 - 0.5m + Fix	C250	100K	<b>25,85 €</b>
93GK.100K.IP.A	Grelha Pass. Inox. 100 - 1m + Fix	A15	100K	<b>41,80 €</b>
93GK.150K.GQ.B	Grelha Entram. Galv.150 -1m + Fix	B125	200K	<b>75,90 €</b>
93GK.150K.GPR.A	Grelha Perf. Galv.150 - 1m + Fix	A15	200K	<b>150,70 €</b>
93GK.150K.FP.C	Grelha FF 150 - 0.5m + Fix	C250	200K	<b>45,10 €</b>
93GK.200K.GQ.B	Grelha Entram. Galv. 200 -1m + Fix	B125	250K	<b>119,35 €</b>
93GK.200K.FP.C	Grelha FF 200 - 0.5m + Fix	C250	250K	<b>62,70 €</b>
93GK.300K.GQ.B	Grelha Entram. Galv. 300 -1m + Fix	B125	350K	<b>199,10 €</b>
93GK.300K.FP.C	Grelha FF 300 - 0.5m + Fix	C250	350K	<b>132,00 €</b>



canais V Plus

V Plus channels

ref	comp.	larg.	altura	V plus	un	preço
	<i>length</i>	<i>width</i>	<i>height</i>		<i>pallet</i>	<i>price</i>
93R.100G.H8	1000	100	80	100	90	61,60 €
93R.100G.00R	1000	100	100	100	56	64,35 €
93R.100G.10R	1000	100	150	100	46	75,90 €
93R.100G.20R	1000	100	200	100	40	85,25 €
93R.100G.30R	1000	100	250	100	45	94,05 €
93R.100G.40R	1000	100	300	100	45	103,95 €
93R.150G.H8	1000	150	80	150	50	72,05 €
93R.150G.H12	1000	150	120	150	50	76,45 €
93R.150G.00R	1000	150	170	150	30	86,35 €
93R.150G.10R	1000	150	220	150	25	94,05 €
93R.150G.20R	1000	150	270	150	20	106,15 €
93R.150G.30R	1000	150	320	150	27	114,95 €
93R.200G.H8	1000	200	80	200	48	77,55 €
93R.200G.H12	1000	200	120	200	36	86,35 €
93R.200G.000R	1000	200	170	200	35	95,70 €
93R.200G.00R	1000	200	220	200	16	107,25 €
93R.200G.10R	1000	200	270	200	16	118,80 €
93R.200G.20R	1000	200	320	200	21	131,45 €
93R.200G.30R	1000	200	370	200	21	143,55 €



grelhas V Plus

V Plus gratings

ref	descrição	V plus	classe	preço
	<i>description</i>		<i>class</i>	<i>price</i>
93GR.100.FRL.C	Grelha FF AT 100 - 0.5m + Rapid-Lock	100	C250	24,75 €
93GR.100.FRL.D	Grelha FF 100 - 0.5m + Rapid-Lock	100	D400	26,95 €
93GR.100.GQA.C	Grelha Galva AT 100 - 1m + Rapid-Lock	100	C250	75,35 €
93GR.150.FRL.C	Grelha FF AT 150 - 0.5m + Rapid-Lock	150	C250	44,00 €
93GR.150.FRL.D	Grelha FF 150 - 0.5m + Rapid-Lock	150	D400	45,10 €
93GR.150.GQA.C	Grelha Galva AT 150 - 1m + Rapid-Lock	150	C250	114,40 €
93GR.200.FRL.C	Grelha FF AT 200 - 0.5m + Rapid-Lock	200	C250	58,30 €
93GR.200.FRL.D	Grelha FF 200 - 0.5m + Rapid-Lock	200	D400	63,25 €
93GR.200.GQA.C	Grelha Galva AT 200 - 1m + Rapid-Lock	200	C250	155,10 €

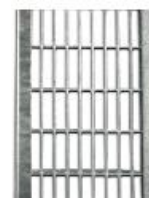

caixas V Plus

sump V Plus

ref	comp.	larg.	altura	V plus	preço
	<i>length</i>	<i>width</i>	<i>height</i>		<i>price</i>
93CX.AR100G	500	100	490	100	215,05 €
93CX.AR150G	500	150	590	150	265,65 €
93CX.AR200G	500	200	550	200	264,00 €



## betão polímero



### canal Sistema K

System K channels

ref	comp.	larg.	altura	sistema k	un	preço
	<i>length</i>	<i>width</i>	<i>height</i>	<i>system k</i>	<i>pallet</i>	<i>price</i>
93KC.150.10R	1000	150	270	150	12	<b>159,00 €</b>
93KC.150.20R	1000	150	370	150	12	<b>178,50 €</b>
93KC.150.30R	1000	150	470	150	8	<b>213,50 €</b>

### canal manutenção Sistema K

System K maintenance channels

ref	comp.	larg.	altura	sistema k	un	preço
	<i>length</i>	<i>width</i>	<i>height</i>	<i>system k</i>	<i>pallet</i>	<i>price</i>
93KCM.150.10R	1000	150	270	150	12	<b>300,50 €</b>
93KCM.150.20R	1000	150	370	150	12	<b>337,50 €</b>
93KCM.150.30R	1000	150	470	150	8	<b>366,50 €</b>

### canal caixa Sistema K

System K box channels

ref	comp.	larg.	altura	sistema k	un	preço
	<i>length</i>	<i>width</i>	<i>height</i>	<i>system k</i>	<i>pallet</i>	<i>price</i>
93KCC.150.10R	1000	150	270	150	12	<b>313,50 €</b>
93KCC.150.20R	1000	150	370	150	12	<b>357,50 €</b>
93KCC.150.30R	1000	150	470	150	8	<b>389,40 €</b>

### caixa Sistema K

System K sump

ref	comp.	larg.	altura	sistema k	un	preço
	<i>length</i>	<i>width</i>	<i>height</i>	<i>system k</i>	<i>pallet</i>	<i>price</i>
93KCC.150.CXB	500	206	380	150	12	<b>SC</b>
93KCC.150.CXI	500	206	380	150	12	<b>SC</b>

### acessórios Sistema K

System K accessories

ref	descrição	altura	sistema k	preço
	<i>description</i>	<i>height</i>	<i>system k</i>	<i>price</i>
93KCA.150.10R.TF	Topo fechado 10R	270	150	<b>37,95 €</b>
93KCA.150.20R.TF	Topo fechado 20R	370	150	<b>51,70 €</b>
93KCA.150.30R.TF	Topo fechado 30R	470	150	<b>58,85 €</b>
93KCA.150.10R.CF	Conector Fêmea / Fêmea 10R	270	150	<b>34,65 €</b>
93KCA.150.20R.CF	Conector Fêmea / Fêmea 20R	370	150	<b>41,25 €</b>
93KCA.150.30R.CF	Conector Fêmea / Fêmea 30R	470	150	<b>47,85 €</b>
93KCA.150.10R.CM	Conector Macho / Macho 10R	270	150	<b>22,00 €</b>
93KCA.150.20R.CM	Conector Macho / Macho 20R	370	150	<b>24,75 €</b>
93KCA.150.30R.CM	Conector Macho / Macho 30R	470	150	<b>28,05 €</b>



## canal Sistema F

system F channels

betão polímero

ref	comp.	larg.	altura	sistema F	un	preço
	length	width	height	system F	pallet	price
93F.100K.00R	1000	100	190	100	52	113,30 €
93F.100K.10R	1000	100	250	100	39	116,60 €
93F.100K.20R	1000	100	310	100	39	132,00 €
93F.150K.00R	1000	150	220	150	45	112,20 €
93F.150K.10R	1000	150	270	150	36	125,40 €
93F.150K.20R	1000	150	320	150	27	147,40 €
93F.150K.30R	1000	150	370	150	27	154,55 €
93F.200K.00R	1000	200	263	200	28	142,45 €
93F.200K.10R	1000	200	313	200	21	154,00 €
93F.200K.20R	1000	200	363	200	21	170,50 €
93F.250K.00R	1000	250	300	250	28	151,25 €
93F.250K.10R	1000	250	350	250	28	158,40 €
93F.250K.20R	1000	250	400	250	21	173,80 €
93F.300K.00R	1000	300	300	300	15	172,15 €
93F.300K.10R	1000	300	390	300	9	194,15 €
93F.300K.20R	1000	300	440	300	9	217,80 €
93F.300K.20R	1000	300	490	300	9	233,75 €
93F.300K.60R	1000	300	600	300	9	290,95 €



## grelhas Sistema F

system F gratings

ref	descrição	sistema F	classe	preço
	description	system F	class	price
93GF.100.FA.D	Grelha FF AT 100 - 0.5m c/ Fix 4P	100	D400	35,20 €
93GF.100.FA.F	Grelha FF 100 - 0.5m c/ Fix 4P	100	F900	38,50 €
93GF.150.FA.D	Grelha FF 150 - 0.5m c/ Fix 4P	150	D400	52,250 €
93GF.150.FA.E	Grelha FF 150 - 0.5m c/ Fix 4P	150	E600	59,40 €
93GF.150.FA.F	Grelha FF 150 - 0.5m c/ Fix 4P	150	F900	61,60 €
93GF.200.FA.D	Grelha FF 200 - 0.5m c/ Fix 4P	200	D400	69,85 €
93GF.200.FA.E	Grelha FF 200 - 0.5m c/ Fix 4P	200	E600	84,70 €
93GF.200.FA.F	Grelha FF 200 - 0.5m c/ Fix 4P	200	F900	84,15 €
93GF.250.FA.C	Grelha FF 250 - 0.5m c/ Fix 4P	250	C250	95,15 €
93GF.250.FA.D	Grelha FF 250 - 0.5m c/ Fix 4P	250	D400	109,45 €
93GF.250.FA.F	Grelha FF 250 - 0.5m c/ Fix 4P	250	F900	167,75 €
93GF.300.FA.C	Grelha FF 300 - 0.5m c/ Fix 4P	300	C250	110,00 €
93GF.300.FA.D	Grelha FF 300 - 0.5m c/ Fix 4P	300	D400	146,85 €
93GF.300.FA.F	Grelha FF 300 - 0.5m c/ Fix 4P	300	F900	221,65 €



## caixas Sistema F

sump system F

ref	comp.	larg.	altura	sistema F	preço
	length	width	height	system F	price
93CX.AF100	500	100	580	100	166,10 €
93CX.AF150	500	150	350	150	113,85 €
93CX.AF200	500	200	363	200	151,25 €
93CX.AF250	500	250	400	250	168,30 €
93CX.AF300	500	300	390	300	185,90 €



## betão polímero

### canais V

V channels



ref	comp.	larg.	altura	classe	un	preço
	<i>length</i>	<i>width</i>	<i>height</i>	<i>class</i>	<i>pallet</i>	<i>price</i>
94V150.D.210	1000	150	210	D400	36	<b>165,00 €</b>
94V200.D.265	1000	200	265	D400	20	<b>209,00 €</b>
94V300.D.385	1000	300	385	D400	12	<b>379,50 €</b>

### caixas V

sump V

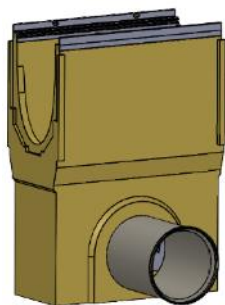
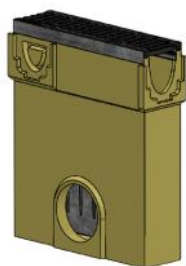

ref	comp.	larg.	altura	classe	preço
	<i>length</i>	<i>width</i>	<i>height</i>	<i>class</i>	<i>price</i>
94V150CX.D	500	150	610	D400	<b>203,50 €</b>
94V200CX.D	500	200	670	D400	<b>209,00 €</b>
94V300CX.D	500	300	860	D400	<b>264,00 €</b>

**grelhas KLine 100**

*KLine 100 gratings*

ref	comp.	larg.	altura	tipo	material	classe	preço
	<i>length</i>	<i>width</i>	<i>height</i>	<i>type</i>	<i>material</i>	<i>class</i>	<i>price</i>
5KL.T0.10H3	1000	100	30	T	galva	A15	<b>38,50 €</b>
5KL.T4.10H3	1000	100	30	T	aisi 304	A15	<b>110,00 €</b>
5KL.T0.10H7	1000	100	70	T	galva	C250	<b>46,20 €</b>
5KL.T4.10H7	1000	100	70	T	aisi 304	C250	<b>121,00 €</b>
5KL.L0.10H7	1000	100	70	L	galva	C250	<b>66,00 €</b>
5KL.L4.10H7	1000	100	70	L	aisi 304	C250	<b>154,00 €</b>



**caixa inspeção KLine 100**

*KLine 100 inspection box*

ref	comp.	larg.	altura	tipo	material	classe	preço
	<i>length</i>	<i>width</i>	<i>height</i>	<i>type</i> <th><i>material</i></th> <th><i>class</i></th> <th><i>price</i></th>	<i>material</i>	<i>class</i>	<i>price</i>
5KL.TC0.10H3	500	100	30	T	galva	A15	<b>66,00 €</b>
5KL.TC4.10H3	500	100	30	T	aisi 304	A15	<b>176,00 €</b>
5KL.TC0.10H7	500	100	70	T	galva	C250	<b>82,50 €</b>
5KL.TC4.10H7	500	100	70	T	aisi 304	C250	<b>198,00 €</b>
5KL.LC0.10H7	500	100	70	L	galva	C250	<b>99,00 €</b>
5KL.LC4.10H7	500	100	70	L	aisi 304	C250	<b>181,50 €</b>



**grelhas KLine 150**

*KLine 150 gratings*

ref	comp.	larg.	altura	tipo	material	classe	preço
	<i>length</i>	<i>width</i>	<i>height</i>	<i>type</i>	<i>material</i>	<i>class</i>	<i>price</i>
5KL.T0.15H3	1000	150	30	T	galva	A15	<b>47,30 €</b>
5KL.T4.15H3	1000	150	30	T	aisi 304	A15	<b>154,00 €</b>
5KL.T0.15H7	1000	150	70	T	galva	C250	<b>60,50 €</b>
5KL.T4.15H7	1000	150	70	T	aisi 304	C250	<b>209,00 €</b>
5KL.L0.15H7	1000	150	70	L	galva	C250	<b>82,50 €</b>
5KL.L4.15H7	1000	150	70	L	aisi 304	C250	<b>220,00 €</b>



**caixa inspeção KLine 150**

*KLine 150 inspection box*

ref	comp.	larg.	altura	tipo	material	classe	preço
	<i>length</i>	<i>width</i>	<i>height</i>	<i>type</i>	<i>material</i>	<i>class</i>	<i>price</i>
5KL.TC0.15H3	500	150	30	T	galva	A15	<b>99,00 €</b>
5KL.TC4.15H3	500	150	30	T	aisi 304	A15	<b>275,00 €</b>
5KL.TC0.15H7	500	150	70	T	galva	C250	<b>121,00 €</b>
5KL.TC4.15H7	500	150	70	T	aisi 304	C250	<b>330,00 €</b>
5KL.LC0.15H7	500	150	70	L	galva	C250	<b>126,50 €</b>
5KL.LC4.15H7	500	150	70	L	aisi 304	C250	<b>308,00 €</b>



## betão polímero

### grelhas KLine 200

*KLine 200 gratings*

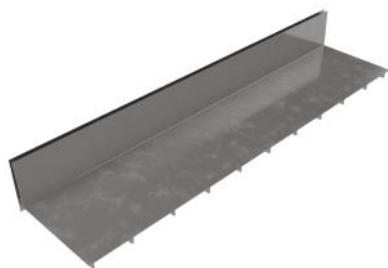

ref	comp.	larg.	altura	tipo	material	classe	preço
	<i>length</i>	<i>width</i>	<i>height</i>	<i>type</i>	<i>material</i>	<i>class</i>	<i>price</i>
5KL.L0.20H11	1000	200	105	L	galva	D400	<b>214,50 €</b>
5KL.L4.20H11	1000	200	105	L	aisi 304	D400	<b>385,00 €</b>



### caixa inspeção KLine 200

*KLine 200 inspection box*

ref	comp.	larg.	altura	tipo	material	classe	preço
	<i>length</i>	<i>width</i>	<i>height</i>	<i>type</i>	<i>material</i>	<i>class</i>	<i>price</i>
5KL.LC0.20H11	500	200	105	L	galva	D400	<b>220,00 €</b>
5KL.LC4.20H11	500	200	105	L	aisi 304	D400	<b>396,00 €</b>

### ENCOMENDA:

- Qualquer encomenda de um cliente implica a aceitação das presentes condições gerais de venda que prevalecem sobre quaisquer outras, salvo a existência de um acordo por escrito entre as partes;
- As encomendas terão de ser formalizadas exclusivamente por escrito (email, fax ou carta);
- Se o cliente cancelar a encomenda no decurso do prazo da execução, fica obrigado a pagar os produtos que já tiverem sido produzidos expressamente para o cumprimento da encomenda;
- A alteração das quantidades constantes da proposta de compra só poderão ser feita com acordo prévio da CAPA e poderão acarretar a modificação das condições de venda acordadas, nomeadamente preço e prazo de entrega.

### PREÇO:

- Os preços desta tabela estão em vigor a partir de 18/04/2026
- Os preços constantes desta tabela são válidos para Portugal Continental e Regiões Autónomas.
- Aos preços a faturar será sempre adicionado o IVA à taxa legal em vigor.

### PRAZO DE ENTREGA:

- Os prazos de entrega dos produtos são variáveis e não poderão ser inferiores aos prazos aproximados constantes da proposta de venda.
- São consideradas como condições de exclusão pelo não cumprimento dos prazos de entrega, as seguintes:
  - ◆ A falta de cumprimento, por parte do cliente, dos prazos de pagamento, ficando as entregas suspensas até ao respetivo cumprimento;
  - ◆ A falta de prestação atempada, por parte do cliente, das informações necessárias à concretização da encomenda;
  - ◆ Os casos de força maior, tais como greves, epidemias, incêndios, inundações, danificação de ferramentas ou outros reveses significativos no processo de fabrico, interrupção ou atraso de transportes, falta de matéria-prima ou qualquer outra causa que provoque uma paralisação na fábrica ou de fornecedores.

### TRANSPORTE:

- Quando o transporte ficar a cargo da CAPA, o cliente obriga-se a garantir a acessibilidade do local de entrega e da descarga do material;
- O cliente deverá rececionar os produtos, verificando o estado e a quantidade da mercadoria e sua conformidade com as guias de remessa e, em caso de perdas ou avarias detetadas no ato da entrega, apresentar a sua reclamação escrevendo-a na guia de remessa do transportador e confirmar a reclamação junto da CAPA por escrito, fundamentando a sua queixa no prazo de 5 dias úteis posteriores à data de entrega da mercadoria;
- Para encomendas iguais ou superiores a 800€ + IVA, o transporte está incluído para entregas em Portugal Continental; Para encomendas de valor inferior a 800€ + IVA, o custo de transporte será por conta do cliente no valor de 45€ + IVA por palete transportada.
- Nos casos em que o cliente realizar o transporte, o carregamento poderá ser efetuado nas nossas instalações sem custos.

### RECLAMAÇÕES:

- Qualquer reclamação só será analisada desde que devidamente formalizada por escrito.

### DEVOLUÇÕES:

- Só serão aceites devoluções para casos excecionais e sujeitas à nossa aceitação prévia;
- Os custos de devolução até ao nosso armazém serão a cargo do cliente;
- A devolução implicará uma depreciação de 20% do valor faturado;
- Serão considerados apenas materiais em bom estado à descarga no nosso armazém.



CAPA, S.A.  
Rua Ribeiro Cambado, 1491  
Alto da Serra  
4440-695 Valongo  
Portugal

Tel : +351 224 219 600  
Fax: +351 224 219 609  
Mail: [comercial@capadrain.com](mailto:comercial@capadrain.com)

[www.capadrain.com](http://www.capadrain.com)



**capa**  
DRAIN